

WATER QUALITY IN CAPITOL LAKE OLYMPIA, WASHINGTON

Prepared for
**State of Washington
Departments of Ecology
and General Administration**

**CH₂M
HILL**

June 1978

S10583.A6



PREFACE

This report on the water quality of Capitol Lake was prepared by CH2M HILL for the State of Washington Departments of Ecology and General Administration under contract WF-PS-77-001.



SUMMARY

Capitol Lake has experienced chronic algal, turbidity, coliform, and sedimentation problems ever since it was formed in 1951. The lake's water quality was studied from January through December 1977 to determine the source of these problems and identify possible solutions.

The studies consisted of measurement and analysis of a number of water quality parameters, with special attention to the parameters associated with several suspected pollutant sources. The primary water quality parameters that were measured are bacterial indicators of sewage pollution (total coliform, fecal coliform, and fecal streptococci), nutrient compounds, algae, and zooplankton. Other parameters measured include dissolved oxygen, temperature, pH, turbidity, specific conductivity, total solids, suspended solids, and Secchi depth. The suspected pollutant sources were storm and sanitary sewer outfalls in the lake, fish rearing in Percival Cove, and the inflow from the Deschutes River and Percival Creek.

The study showed that Capitol Lake's water quality problems result from both natural and manmade causes. Most important, the lake is manmade and is located on a former tidal flat that is a natural area for sediment deposition and high productivity. Nutrients, sediments, and bacteria accumulated along the river's course pass into the lake. The major determinants of water quality in the watershed are predominately nonpoint sources of pollution along the Deschutes River, but some point sources exist within the lake.

A more detailed summary of the study results follows.

SOURCES OF INDICATOR BACTERIA

Sources of indicator bacteria were determined by collecting samples in a grid of stations and analyzing the samples for various parameters. This analysis was then used to determine whether the pollutant sources for the various sections of the lake are of human or nonhuman nature.

Pollutant sources are sometimes differentiated on the basis of the ratios of fecal coliform to fecal streptococci bacteria (FC:FS) concentrations in water. In freshly polluted waters, a ratio of more than 4 is indicative of human fecal pollution, and a ratio of less than .7 indicates animal pollution. However, this method of differentiating the source of fecal pollution has several limitations. First, the ratio changes with time, making difficult the interpretation of FC:FS ratios in samples of unknown time of pollutant discharge. Second, the ratios work best for either pure domestic waste or pure animal waste. Mixtures of animal and human wastes give intermediate ratios. Such mixtures occur in Capitol Lake, and the time of discharge is unknown.

Despite these limitations of the use of FC:FS ratios, it can be concluded that contributions of indicator bacteria in Capitol Lake are dominated by the Deschutes River and waterfowl on the lake. Waterfowl could also be a major source of bacteria in the river segment sampled in this

study. The combination of the river inputs and waterfowl inputs determines the overall pattern and levels of indicator bacteria in the lake.

The lakewide FC:FS ratios and the bacteria concentrations at the pipe sampling stations were not high enough to consistently indicate human fecal pollution. Stations 5 and 52 (pipe discharges to the swimming area and to the middle basin, respectively) might occasionally receive domestic waste because of leakage from nearby sewer mains. The numerous culverts and pipes that enter the west side of the north basin might also discharge domestic waste occasionally. However, no pipe was indicated as a major discharge of human fecal pollution.

Seasonally, bacteria indicators were all high during the fall. Total coliform levels were highest in October and high in July. Fecal coliform showed a late-summer through fall peak, with an additional peak in early spring. Fecal streptococci levels began to rise in July and continued at high levels for the rest of the year.

Lakefair activities are not implicated in any increase of indicator bacteria in the lake. A measured bacterial increase that occurred during the fair was due to an increased contribution from the Deschutes River.

EFFECTS OF FISH REARING IN PERCIVAL COVE

Fish-rearing activities in Percival Cove have no detrimental effect on the lake. Nutrients added to the lake through fish food do not contribute significantly to the lake's nutrient budget, and the timing of this input does not coincide with periods of maximum algal growth. The water quality in the cove is statistically indistinguishable from other parts of the lake. If anything, fish operations help improve the water quality through the beneficial effects of "bumping" (flushing) the lake. Flushing lowers the algal growths and increases water clarity.

NUTRIENT INPUTS

Nutrient inputs are dominated by the Deschutes River. The nutrient inputs for both total and available forms of nitrogen and phosphorus are extremely high. These high nutrient input levels cause abundant algae in the lake. Pipes are not implicated as having any significant effect on nutrient loadings or algal standing crops.

During the early part of the growing season, phosphorus appeared to be limiting to algal growth. But during the latter part of the growing season, nitrogen became limiting. The change is due to a larger percentage decrease in phosphorus loading than in nitrogen loading as discharge from the Deschutes River decreases during the summer.

ALGAE AND ZOOPLANKTON

The algal growths apparent in the lake are a direct result of the lake's high nutrient loadings, which come mostly from the Deschutes River. The

worst type of algae (*Anabaena*) begins to bloom in midsummer (June-July), but the bloom was stopped by flushing the lake. Lake flushing appears as a very effective mechanism for controlling algal growth and particularly for controlling *Anabaena*. The other two dominant algae, *Stichococcus* and *Cyclotella*, are much less unaesthetic than *Anabaena*, which forms floating mats that can accumulate in downwind corners.

Zooplankton do not appear to have any potential for controlling algae in the lake. A change in the zooplankton species from *Bosmina coregoni* to *B. longistrostris* indicates poorer water quality in 1977 than in 1955. Zooplankton are adversely affected by flushing, although rotifers, some of which are tolerant of saline water, are not hurt as much as other zooplankton.

OTHER WATER QUALITY PARAMETERS

Other water quality parameters displayed patterns consistent with the finding of no point sources. Dissolved oxygen occasionally was below the Class A standard (8 mg/l). Lowest oxygen saturations occurred after lake flushing, presumably because of decaying algae. The Secchi depth and turbidity (indicators of water clarity) were mainly affected by suspended solids discharged through the Deschutes River. Algal growth diminishes Secchi depth during the growing season. Specific conductivity, total solids, and suspended solids increased dramatically when the lake was flushed and returned to near-normal levels between flushings.

SWIMMING AREA

Biologically and chemically, the swimming area is indistinguishable from the other sampling stations in the lake. This means that the water quality in the swimming area is no less acceptable than in other portions of the lake. Subjective evaluations of poorer water quality in the area are based either on people's higher use of and proximity to the area or on occasional accumulation of algal mats that are blown there by the wind.



RECOMMENDATIONS

INDICATOR BACTERIA

Because no pipes are indicated as consistent or direct dischargers of domestic waste to Capitol Lake, pipe diversions will not significantly alter indicator bacteria levels. Several pipes, particularly those at stations 5, 52, and along the west side of the north basin, might occasionally act as conduits for nearby sewer mains. Diversion of these pipes might be merited for public health considerations.

High levels of indicator bacteria appear to originate from the Deschutes River and waterfowl, so that only waterfowl control and watershed management would be effective in reducing overall bacteria levels. Watershed management is advisable for both bacteria and nutrient control, but waterfowl control is not recommended. Waterfowl are a recreational asset to the lake, and less desirable species such as coots cannot be controlled without simultaneously reducing other species' populations.

NUTRIENT MANAGEMENT WITHIN THE LAKE

Because of the high continuous input of nutrients to the lake, no chemical and physical lake management scheme will be effective. Only one in-lake nutrient management strategy appears feasible. The south and middle basins could be converted to freshwater marshes so that they can act as both sediment and nutrient traps. The advantages of conversion to freshwater marsh include waterfowl enhancement and creation of a natural system that coincides with the basic ecological succession for the area. Disadvantages are that this scheme is in direct conflict with existing dredging and rehabilitation plans that call for open water in the south and middle basins. The feasibility of using a freshwater marsh for nutrient control will need further study. The decision on which rehabilitation scheme to undertake will be a value decision weighing human desires for lake recreation opportunities against the continuation of the existing algal problems. But even with the freshwater marsh, water quality cannot be expected to be more than moderately acceptable.

INCREASED FREQUENCY OF FLUSHING

Flushing is effective in stopping algal blooms and is particularly effective in controlling *Anabaena* growth. An increased frequency of flushing might help the lake stay much cleaner, and an optimal flushing frequency and schedule should be determined. A flushing scheme must be based partly on water quality problems in Budd Inlet and must be coordinated with fish-rearing needs. Using a computer model of algal growth and the data from this study would provide the most efficient design of a flushing scheme.

More frequent flushing is currently the only immediate management scheme that could improve water clarity in the swimming area. However, flushing is at best a cosmetic solution because it only removes algae and does not eliminate the nutrient input that causes the algal growth.

CONTENTS

	<u>Page</u>
Preface	iii
Summary	v
Recommendations	ix
1 Introduction	1
Study Objectives	1
Ecosystem Description	1
2 Study Description	11
Sources of Indicator Bacteria	11
Effects of Fish-Rearing Activities	14
Sources and Effects of Nutrient Compounds	15
Data Analysis	15
3 Analysis and Results	17
Indicator Bacteria in Capitol Lake	17
Effects of Fish Feeding Operations on Percival Cove	41
Nutrients in Capitol Lake	42
Algae and Zooplankton	61
Additional Water Quality Parameters	69
Swimming Area	73
References	75
Bibliography	77
Appendix A Description of Synoptic Stations	A-1
Appendix B Data Analysis and Reports	B-1
Appendix C Statistical Analysis	C-1

TABLES

	<u>Page</u>
1 Routine Monitoring Sample Dates During 1977	11
2 Fecal Coliform and Fecal Streptococcus Densities From Various Sources	19
3 Calculation of Indicator Bacteria Excretion Rates By Waterfowl	33
4 Comparison of Fish Food Loadings To Natural Loadings of Nutrients In Percival Cove	42
5 Correlation of Specific Conductance to Indicator Bacteria, Nutrients, and Water Clarity During the Summer	57
6 Correlations of Selected Water Quality Parameters to Discharge, Rainfall, and Water Temperature	58
7 Algae Identified in Capitol Lake, 1977	62
8 Capitol Lake Algal Volumes	63
9 Correlations of Biological Characteristics To Physical and Biological Parameters	64
10 Zooplankton Identified in Capitol Lake, 1977	68

FIGURES

1 Capitol Lake Drainage Basin	2
2 Capitol Lake Bottom Contours	4
3 Terrestrial and Aquatic Vegetation	6
4 Capitol Lake Flow Pattern	7
5 Tidal Effects on Capitol Lake Flows	9
6 Utilities and Pipes Discharging to Capitol Lake	10
7 Synoptic Survey Station Locations and Flows	12
8 Routine Monitoring Station Locations and Flows	13
9 Deschutes River Discharge and Indicator Bacteria Densities	21
10 Total Coliform Loading Rates and Lake Concentrations	22
11 Distribution of Mean Total Coliforms by Station	23
12 Fecal Coliform Loading Rates and Lake Concentrations	25
13 Distribution of Mean Fecal Coliform Concentration by Station	26
14 Fecal Streptococci Loading Rates and Lake Concentrations	28
15 Distribution of Mean Fecal Streptococci Concentration by Station	29
16 Distribution of FC:FS Ratios by Station	30
17 Lake and Basin FC:FS Ratios, 1977	31
18 Occurrence of FC:FS Ratios Greater Than 4:1	32
19 Changes in FC:FS Ratios With Time	35
20 Distribution of Indicator Bacteria Densities During Lakefair	37

21	Bacteria Density Changes in North Basin During Lakefair	38
22	Distribution of Indicator Bacteria Densities During Synoptic Surveys	39
23	Total Coliform Loading Rates and Concentrations in Percival Cove	43
24	Fecal Coliform Loading Rates and Concentrations in Percival Cove	44
25	Fecal Streptococci Loading Rates and Concentrations in Percival Cove	45
26	Algae and Zooplankton in Percival Cove	46
27	Total Phosphorus and Ortho-phosphate Loadings and Concentrations By Basin	48
28	Discharge and Nutrient Concentrations, Deschutes River	49
29	Lake Trophic State According to Vollenweider Model	50
30	Distribution of Mean Nitrate-Nitrogen Concentrations By Station	52
31	Distribution of Mean Ammonia-Nitrogen Concentrations By Station	53
32	Distribution of Mean Ortho-Phosphate Concentrations By Station	54
33	Distribution of Mean Total Phosphorus Concentrations By Station	55
34	Nitrate and Ammonia Loadings and Concentrations by Basin	56
35	Distribution of Mean Kjeldahl Nitrogen Concentrations by Station	59
36	Relative Loadings and Sources of Ortho-Phosphate and Inorganic Nitrogen	60
37	Ratio of Available Nitrogen to Phosphorus as an Indication of Limiting Factor	65
38	Average Algal Indicators for All Stations	66
39	Algal Biovolume and Dominant Species Composition	67
40	Zooplankton Abundance	70
41	Percent Saturation, Secchi Depth, Turbidity, and Conductivity	72
42	Total Solids, Suspended Solids, and pH	74

STUDY OBJECTIVES

Capitol Lake is a shallow, eutrophic (enriched with nutrients) lake located in Olympia, Washington. The lake, created in 1951 by building the Fifth Avenue Dam across the mouth of the Deschutes River, has shown chronic algal, turbidity, coliform, and sedimentation problems. However, the lake remains an important resource to the State of Washington because of its location near the capitol and the recent construction of recreational swimming facilities.

In December 1976 CH2M HILL was retained by the State of Washington Department of Ecology to conduct investigations of the coliform and nutrient conditions of the lake. The goals of the investigations were:

- Define the principal sources of coliform bacteria to Capitol Lake and their relative contributions, and determine whether the bacteria are predominantly of human or animal origin.
- Determine the effect of the fish-rearing (feeding) program in Percival Cove on water quality in the lake.
- Define the principal sources of nutrient compounds to the lake and their relationship to Capitol Lake.
- Define and discuss the various alternatives available for correcting the sources of contamination identified during the study.
- Recommend the most feasible and cost-effective correction alternative(s).

ECOSYSTEM DESCRIPTION

Drainage Basin

Capitol Lake is at the mouth of the Deschutes River and receives drainage from an area of 177 square miles (303 sq km). The Deschutes River basin comprises 162 square miles (92 percent) of this area, while the next largest watershed is that of Percival Creek (13 square miles or 7 percent), with the east and west shore drainage (1.6 square miles) and surface area (0.44 square mile) of the lake accounting for the last 1 percent of the total drainage area (Ref. 1). The drainage basin is shown in figure 1.

The Deschutes River basin has a maximum elevation of 3,840 feet (at Cougar Mountain) and is approximately ten times as long as it is wide. The basin is covered by coniferous forest that supports intensive wood products industries and scattered farming. The rivercourse runs through lightly urbanized areas before entering the lake. Pollution

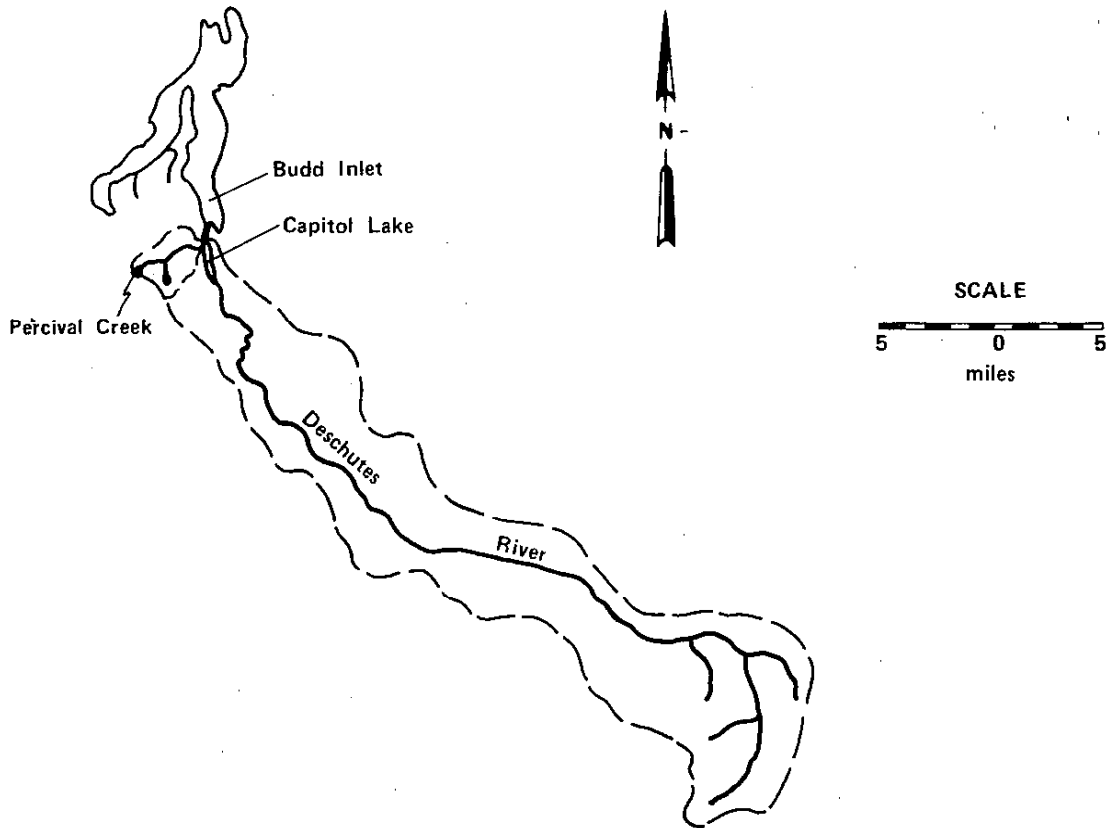

Figure 1

CAPITOL LAKE DRAINAGE BASIN

sources along the river are predominantly of the nonpoint type, with fertilizing, farming, irrigation, logging, and gravel excavation operation the activities likely to cause nonpoint source pollution. Point sources might be the Deschutes holding pond and the Olympia Brewing Company.

The Percival Creek watershed is an area of 13 square miles containing Blake Lake (576 acres) and Trospen Lake (17 acres). The area is mostly covered with natural vegetation and second-growth timber. Development is generally limited to individual residences and businesses. The undeveloped areas are covered with Douglas fir, cedar, and several species of deciduous trees, and there is an undergrowth of shrubs and vines. This area will be developed to a much higher intensity of human use in the near future.

Climate

The Puget Sound area is characterized by mild wet winters and warm dry summers, with approximately 85 percent of the annual mean rainfall of 50 inches occurring from October through April. During the study period, winter air temperatures reached a minimum of 15°F (5 January) and a summer maximum of 98°F (17 August).

Fall rains begin about mid-October and continue with few interruptions through spring. The winter temperatures undergo little fluctuation, with normal winter temperature varying between 40° and 50° in the daytime and the 30's in the nighttime. The area is usually cloudy through most of the winter.

In spring, the length of time between storms gradually increases. Skies are typically clear at night, but followed by fog or low stratus clouds in the early morning. The clouds and fog usually dissipate by noon. About two-thirds of the days are sunny in July through September, and about one-half in May and June. Maximum temperatures (between 70° and 80°F) are usually reached during July, August, and September.

Rainfall typically averages 1 inch per month in July and August and about 2 inches per month in May, June, and September. Precipitation averages about 6.5 inches per month during the period from October through April. The maximum rainfall occurred in December during the study, and the minimum in July. August had an abnormal 4.2 inches and January had 1.7 inches of precipitation.

Physical-Biological Description of Capitol Lake

The area inundated by Capitol Lake was formerly the tidal flats of Percival Creek and the Deschutes River. The total lake covers an area of about 220 acres and has a volume of 2,272 acre-feet and mean depth of 10 feet. The maximum depth is 22 feet, which occurs in the north basin. Broad, shallow, flat areas occur extensively in the littoral areas of the middle and south basins (figure 2). Constrictions between basins play important roles in determining waterflow. Both constrictions, one created by Interstate 5 between the south and middle basins

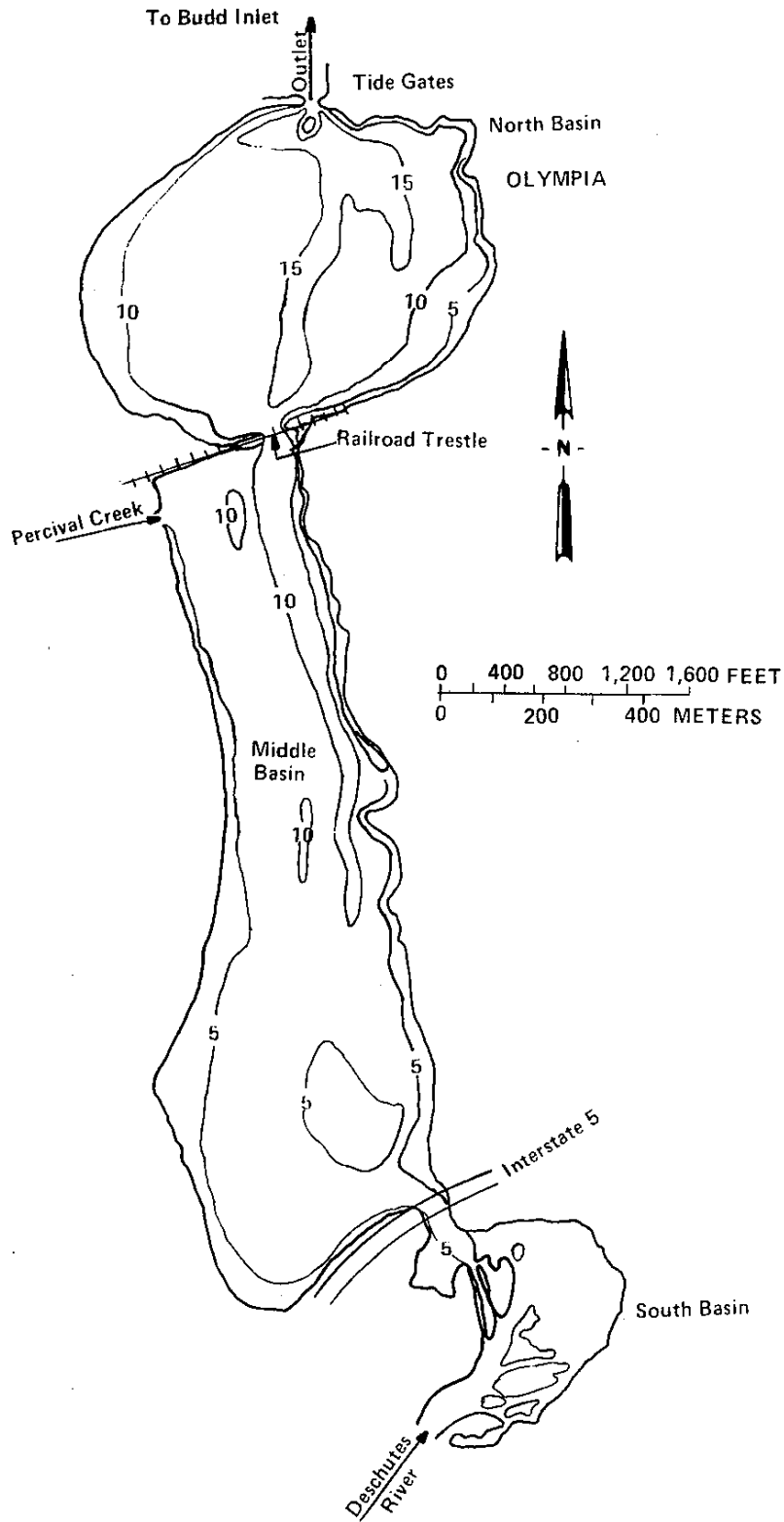

Figure 2
CAPITOL LAKE BOTTOM CONTOURS

and the other by the railroad between the middle and north basins, channel the flow toward the eastern side of the middle basin. Percival Cove, a small basin located on the northwest side of the middle basin, receives the inflow of Percival Creek.

The south basin is the smallest and shallowest of the main lake areas, with a surface area of approximately 30 acres and a mean depth of about 2 feet. This basin has several islands and is quickly being reduced in volume by continuous deposition of sediments carried by the Deschutes River. This basin has abundant aquatic vegetation including cattails, rooted aquatics, *Potamogetan* and *Elodea*. The surrounding lake area is covered by mature mixed deciduous woods, and there is a belt of scotch broom, grasses, and blackberries along the I-5 area.

The middle basin is the largest, covering 146 acres at an average depth of 7 feet. Shoreline banks are steep, yielding a relatively flat-bottomed basin. Sediment deposition is creating a shallow area at the southwest corner of the basin. The dominant river flow pattern is along the east shore, with both the northwest and southwest corners having a longer resident time for water mass than the rest of the basin. Percival Cove enters this basin at the northwest corner.

The east side and lower two-thirds of the west side have areas of rooted aquatics including cattails and *Potamogetan*. Immediate shoreline vegetation along the east side is mostly mixed deciduous forest with bands of mixed conifers. The west side has a band of landscaped area backed by the Deschutes Parkway and mixed deciduous woods (figure 3).

Percival Cove covers an area of approximately 23 acres on the west side of the lake. The cove is used for salmon rearing by the Department of Fisheries. Flow through the area is dominated by Percival Creek. Its flow direction has been modified by a stream deflector (figure 4). The cove is also suffering from sediment deposition due to erosion in the Percival Creek drainage basin. The area has *Potamogetan*, *Elodea*, and cattails beds.

These two main basins and Percival Cove are habitat for waterfowl nesting and roosting. The surrounding areas have abundant terrestrial bird populations. Numerically important permanent waterfowl include mallards, glaucous winged gulls, and coots, with winter residents consisting of pintail, teal, grebes, loons, goldeneye, ruddy ducks, Canadian geese, gulls, and several other species. These birds are important as possible sources of both coliforms and nutrients. The entire lake is used by diving ducks, but dabbling ducks stay largely in the southern basin.

The northernmost basin is the deepest, showing a maximum depth of 22 feet and an average depth of 11 feet. This basin covers 104 acres and has a swimming area in the northeastern section. The basin is frequented by diving ducks and by waterfowl taking refuge from stormy conditions in Puget Sound.

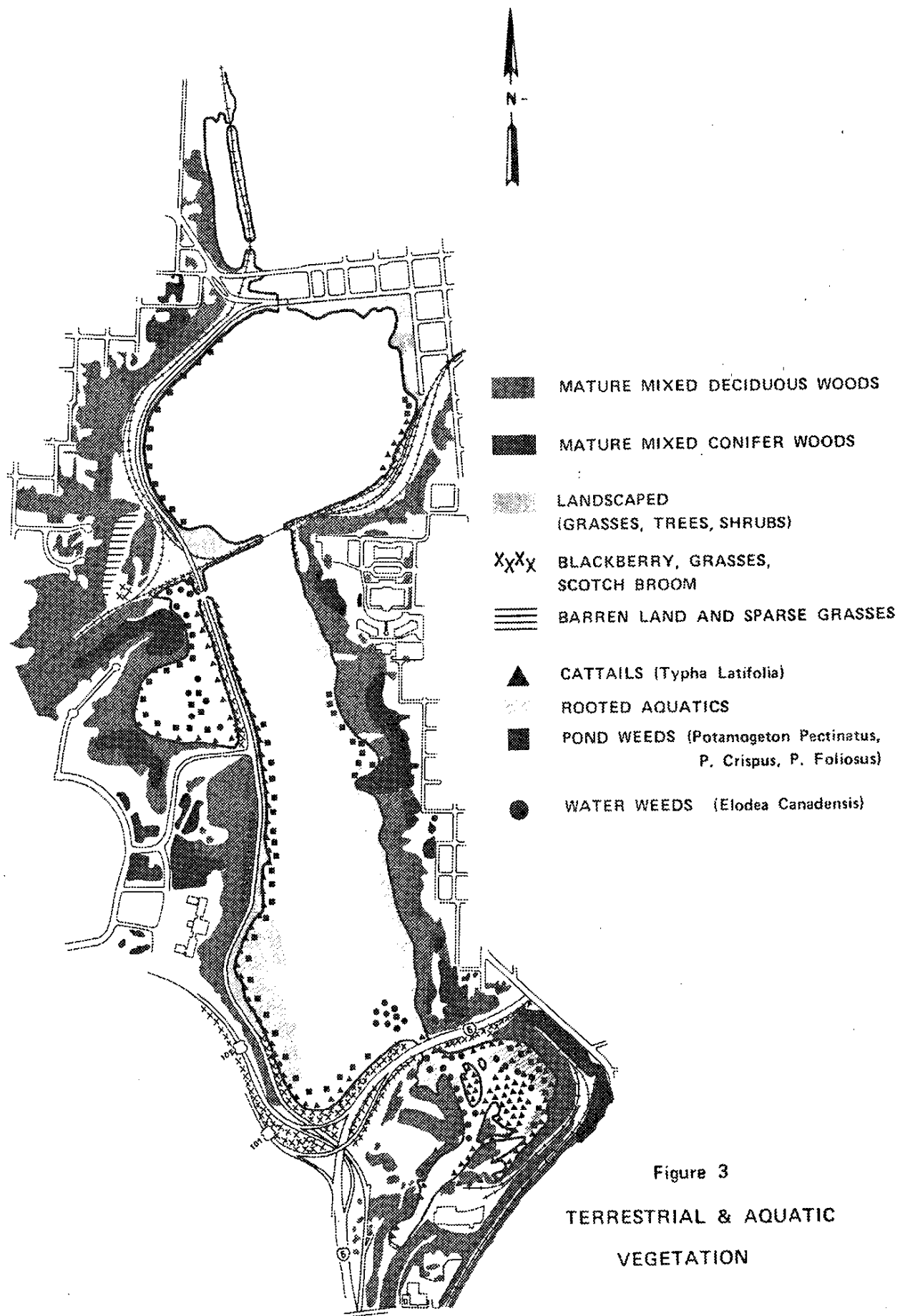

Figure 3
 TERRESTRIAL & AQUATIC
 VEGETATION

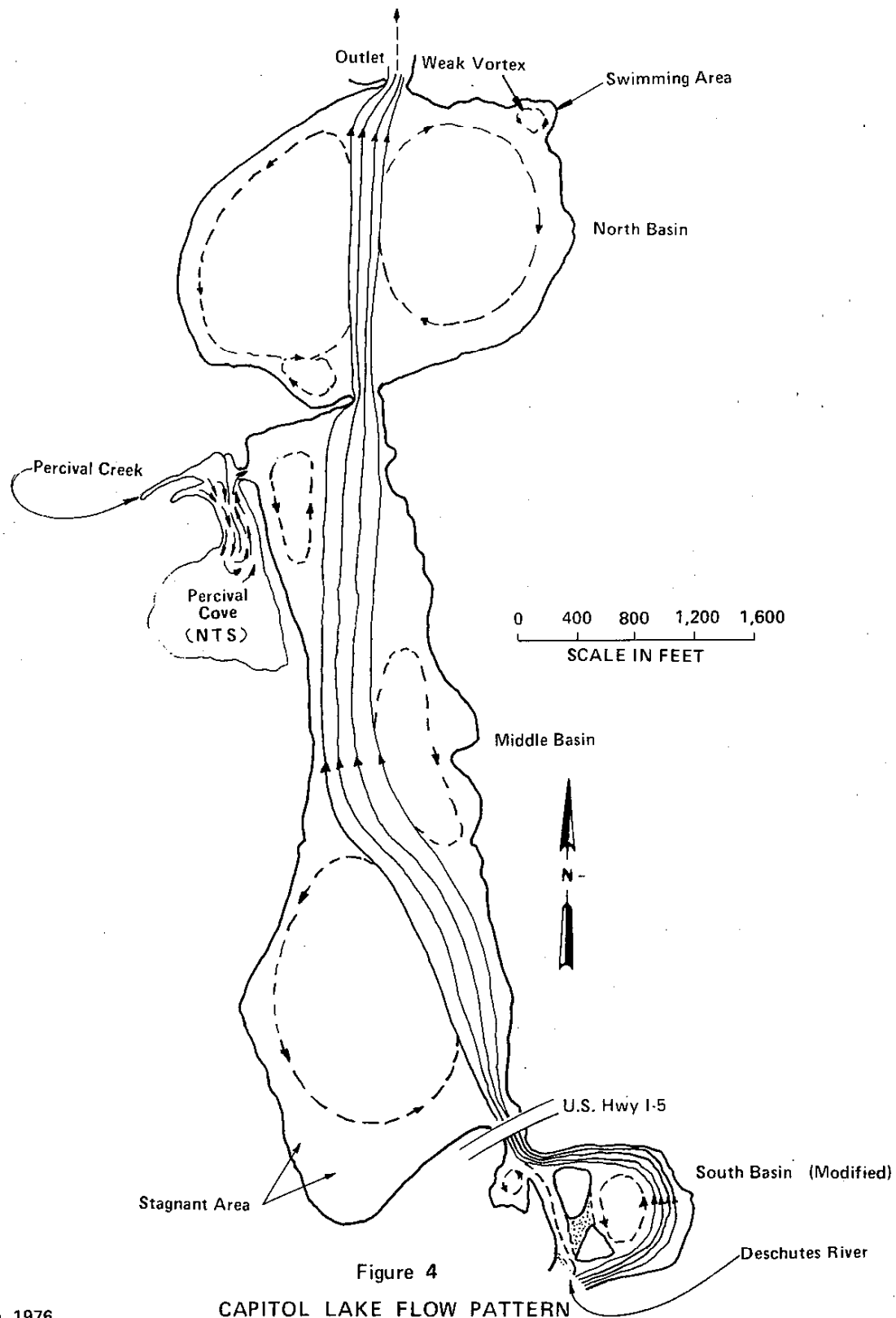

Figure 4

CAPITOL LAKE FLOW PATTERN

Source: Orsborn, 1976

The volumes and relative turnover times of each of these basins are:

<u>Basin</u>	<u>Volume (ac-ft)</u>	<u>Volume (Percent)</u>	<u>Relative Turnover</u>	<u>Average Turnover (Days)</u>
Total Lake	2,272	100	1	2.6
S. Basin	60	3	37	0.07
M. Basin	1,022	45	2.2	1.2
N. Basin	1,144	50	2.0	1.3
Percival Cove	46	2	3.3	0.78

The average lake replacement time is 2.6 days (using mean inflows of 405 cfs for the Deschutes River and 30 cfs for Percival Creek), but the replacement time of each basin deviates greatly from this. Replacement times for the lake vary from 0.2 day during the average 2-year flood to 9.3 days during the average annual (2-year) low. During 1977, the average replacement time was 2 days. Flow through the lake is far from uniform, with replacement times being low along the main flow areas (the east side of the south and middle basins and through the middle of the north basin) and longer in circulation cells at the west side of the south and middle basins and at both sides of the north basin. These flow patterns and cells are shown in figure 4.

Two other actions complicate the hydrology of Capitol Lake. First, flow-through is influenced by tides, giving maximal flow at low tides and no flow-through during maximal high tides. Second, the lake is periodically flushed with saltwater to stimulate salmon migration, with the added benefit of aquatic weed control. During this study, flushing took place on 19 May, 14 July, and 10 September, with each episode spanning approximately 3 days. Tidal effects on flow are shown in figure 5.

Additional sources of minor amounts of water and a possible major source of pollutants are the sewer and storm drains that enter the lake. These are shown in figure 6.

Lake use immediately around the lake is predominantly commercial, industrial, and urban and suburban residential. The capitol building steamplant discharges about 200 gallons per day (gpd) of cooling water. In addition, transportation corridors take up a good deal of land, and two parks are located at the lake.

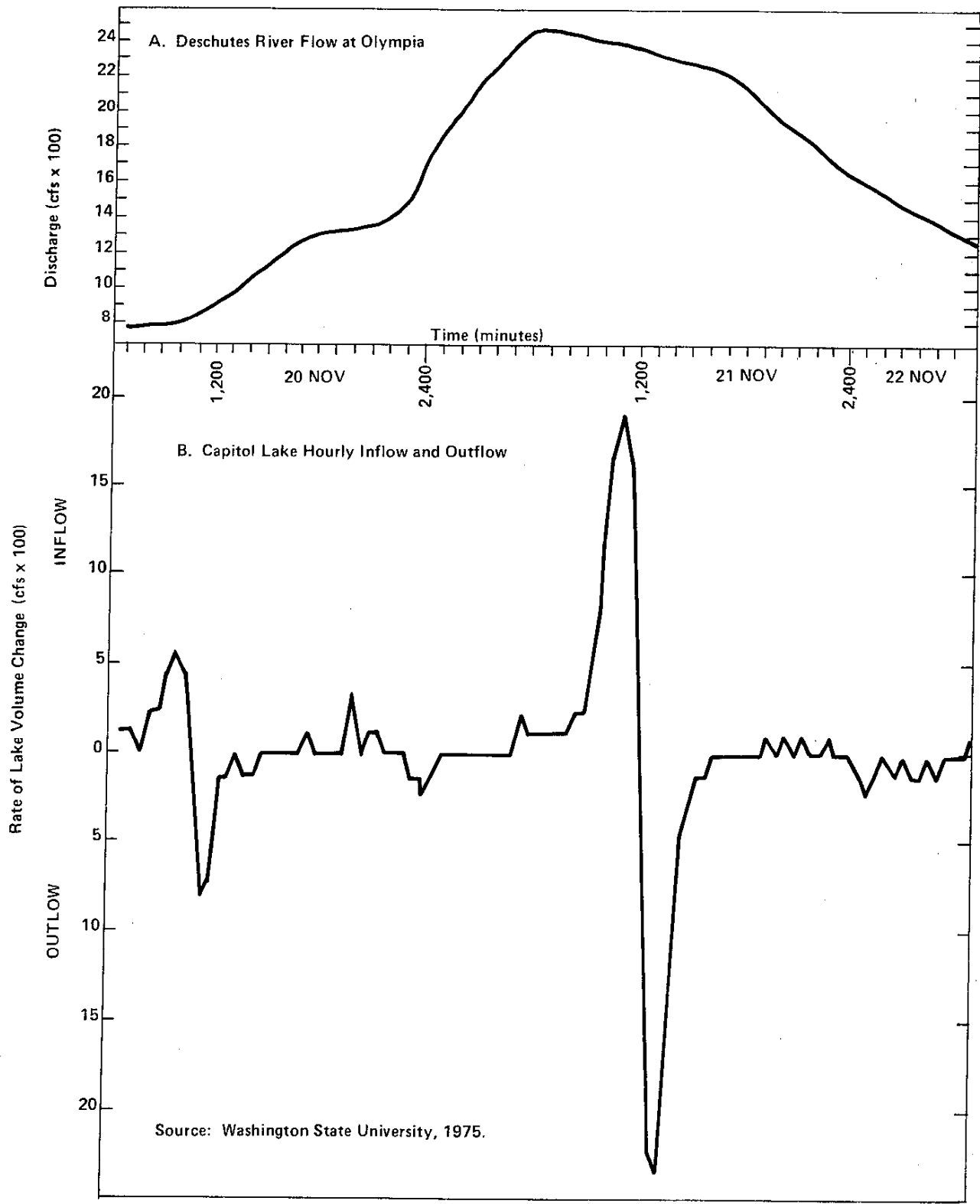

Figure 5
TIDAL EFFECTS ON CAPITOL LAKE FLOWS

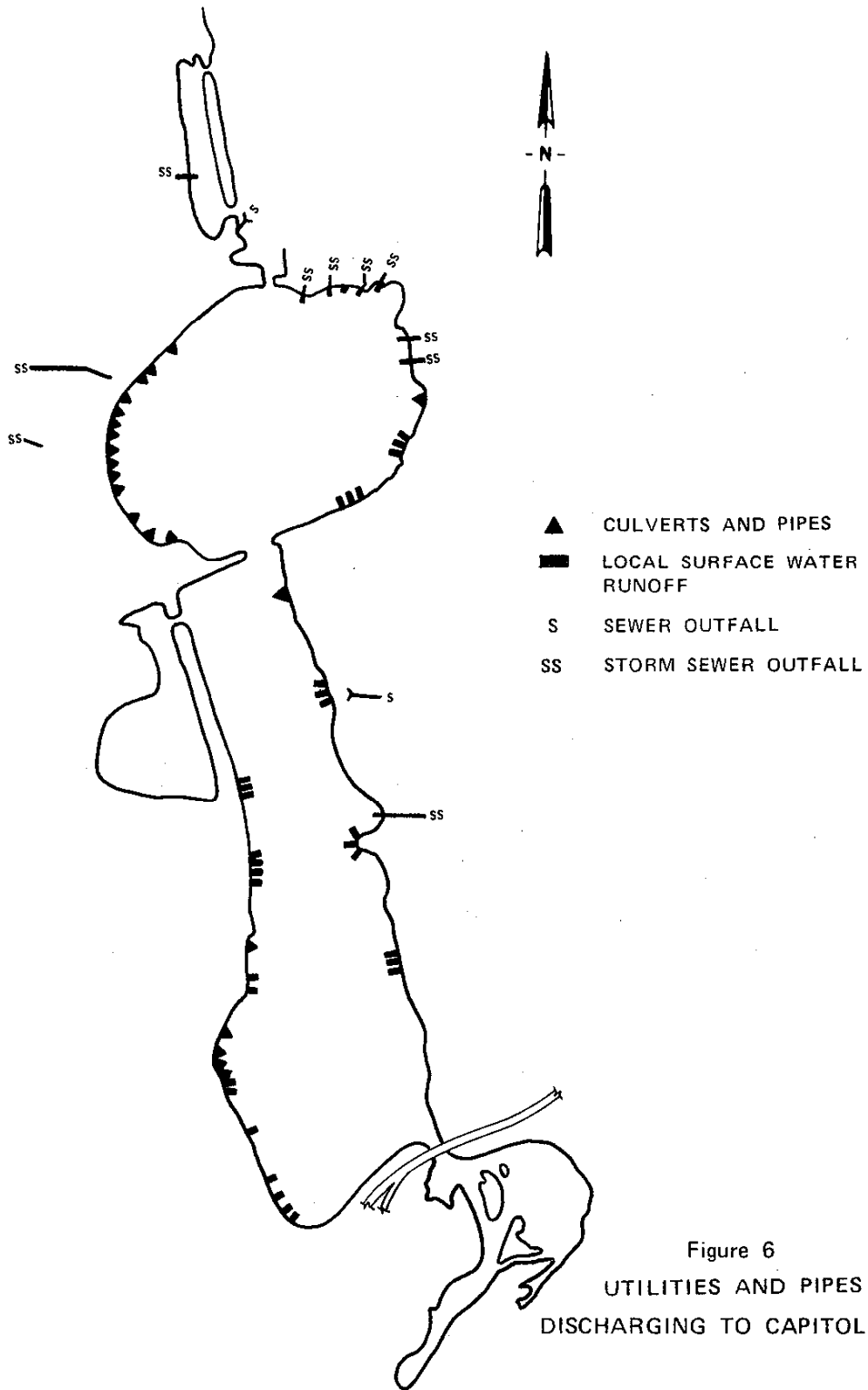

Figure 6
UTILITIES AND PIPES
DISCHARGING TO CAPITOL LAKE

SOURCES OF INDICATOR BACTERIA

At the outset of the study (January 1977), a field survey of Capitol Lake and its immediate drainage basin was conducted. This survey was intended to identify inflow pipes that could be important contributors of runoff water and domestic sewage. A major problem immediately became apparent during this survey. Many of the pipes are below the surface of the water, preventing any sampling or the determination of exact contributions from each pipe. The only feasible sampling strategy was to set up a grid of lake sampling stations to determine relative rather than exact contributions. This strategy was adequate to detect any "significant" sewage discharge (a discharge large enough to overshadow background variations and mixing).

Two sampling grids were established: a synoptic grid and a routine sampling grid. The synoptic grid consisted of 50 lake and inflow stations at which samples were taken for analysis of total coliforms and turbidity. Grab samples were collected at nine additional stations. The synoptic stations are shown in figure 7A and are described in appendix A. Figure 7B is a schematic of these stations showing the probable direction of current flow between stations. This intensive sampling program was conducted on 6 January, 6 May, 29 September, and 4 December. On all sampling runs, total coliform and turbidity were measured. On the last two runs, fecal coliform and fecal streptococci were also measured.

On the basis of the field survey and the first synoptic sampling run, permanent routine sampling stations were established. Twenty-five stations were chosen; eighteen of these were in lakes and rivers, one in Budd Inlet, and six in storm sewers (figure 8). These stations were sampled routinely on a bimonthly basis; the sampling dates are given in table 1.

Table 1. ROUTINE MONITORING SAMPLE DATES DURING 1977

18 January	22 July
1 February	9 August
15 February	23 August
7 March	6 September
22 March	10 September
5 April	4 October
19 April	18 October
3 May	1 November
24 May	15 November
7 June	29 November
21 June	13 December
5 July	27 December
12 July	

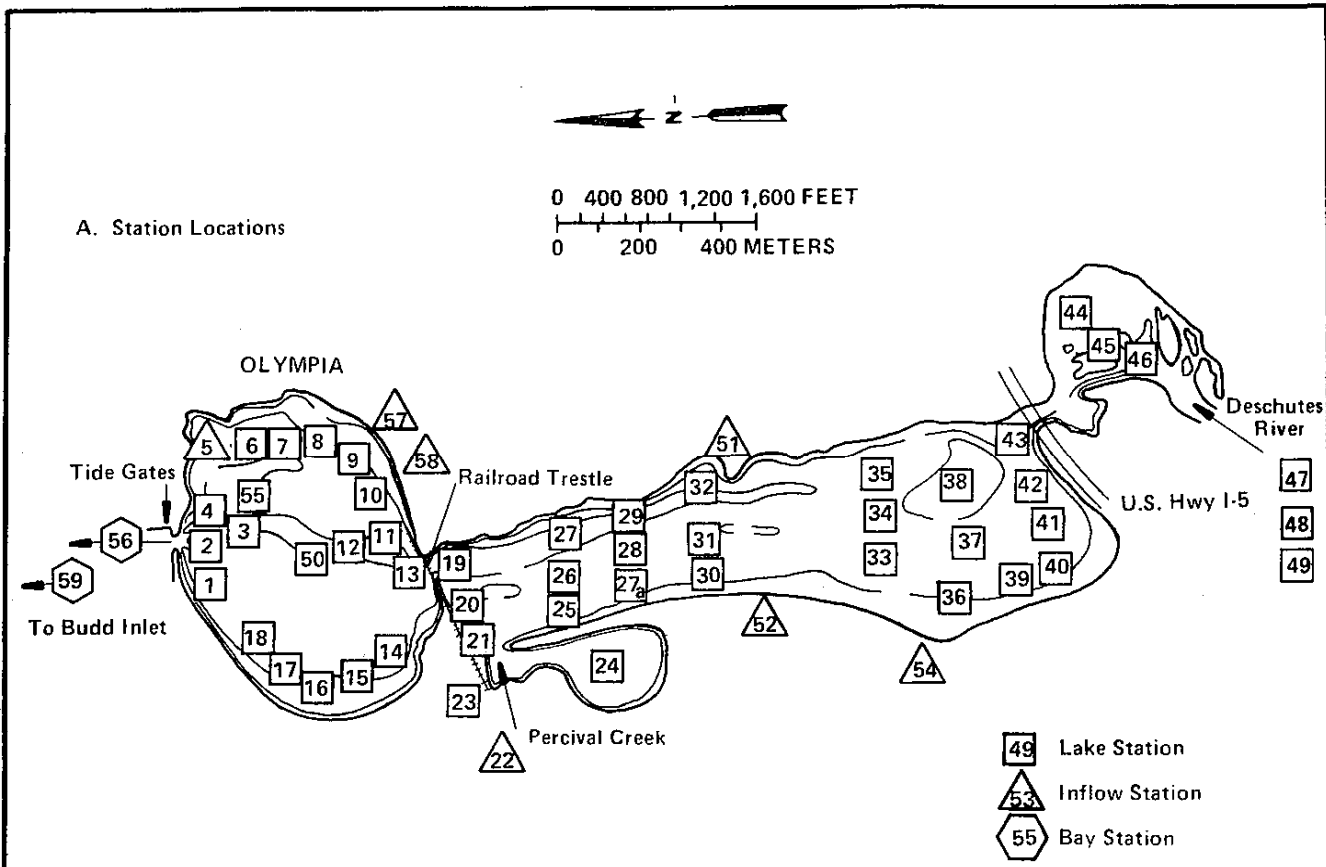

B. Flows

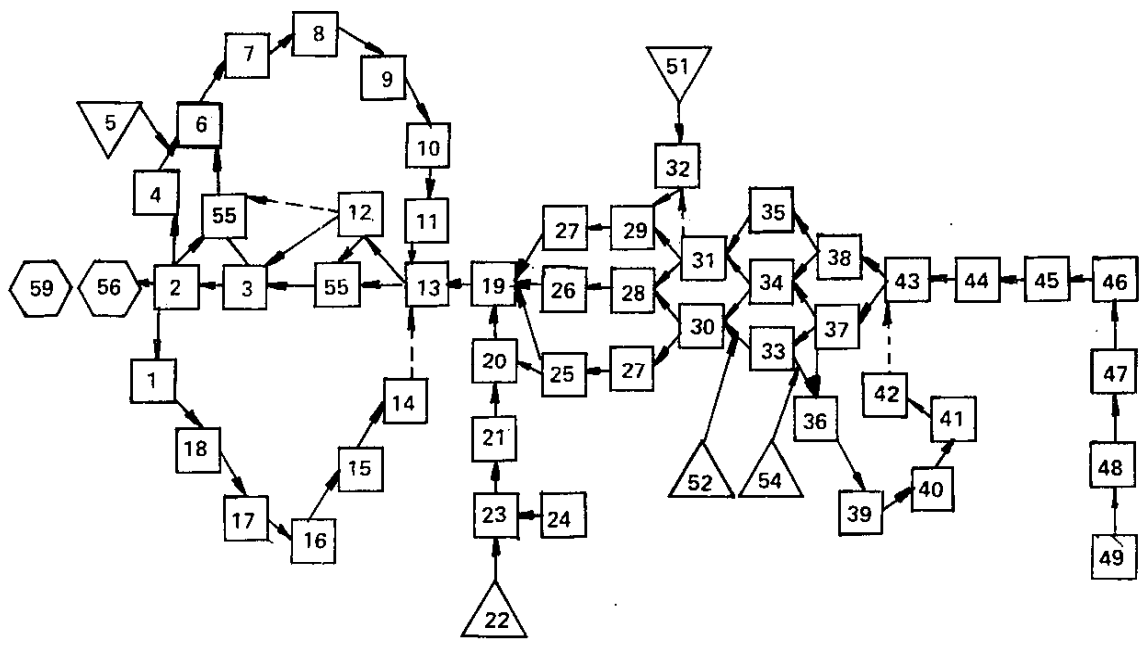
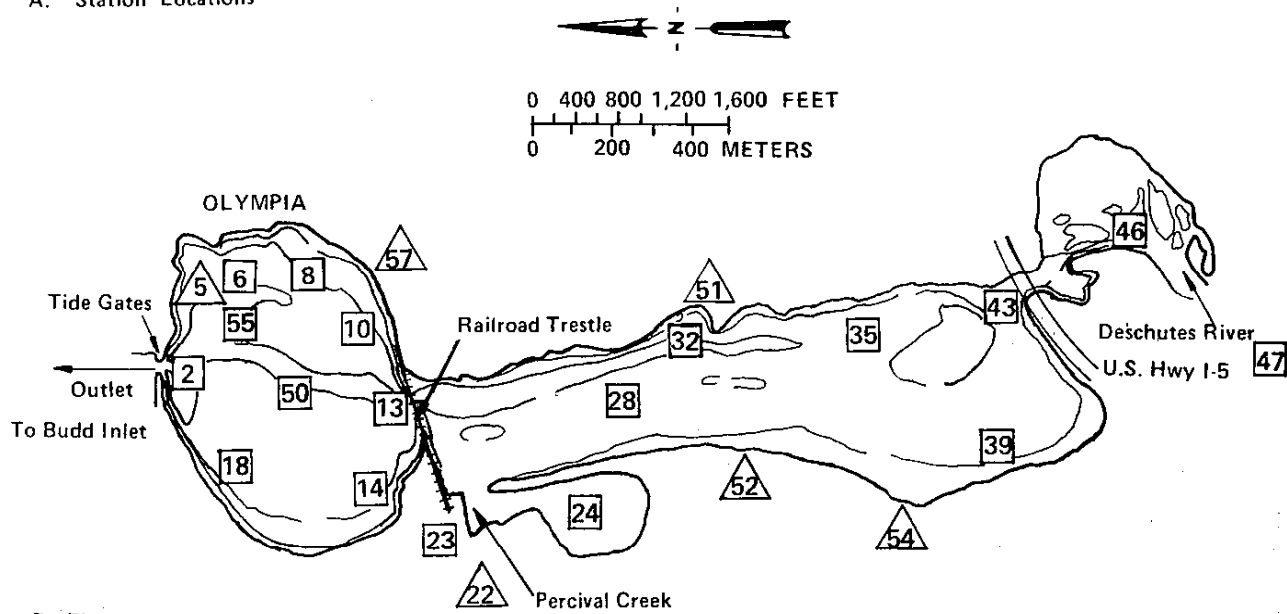

Figure 7
SYNOPTIC SURVEY STATION LOCATIONS AND FLOWS

A. Station Locations



B. Flows

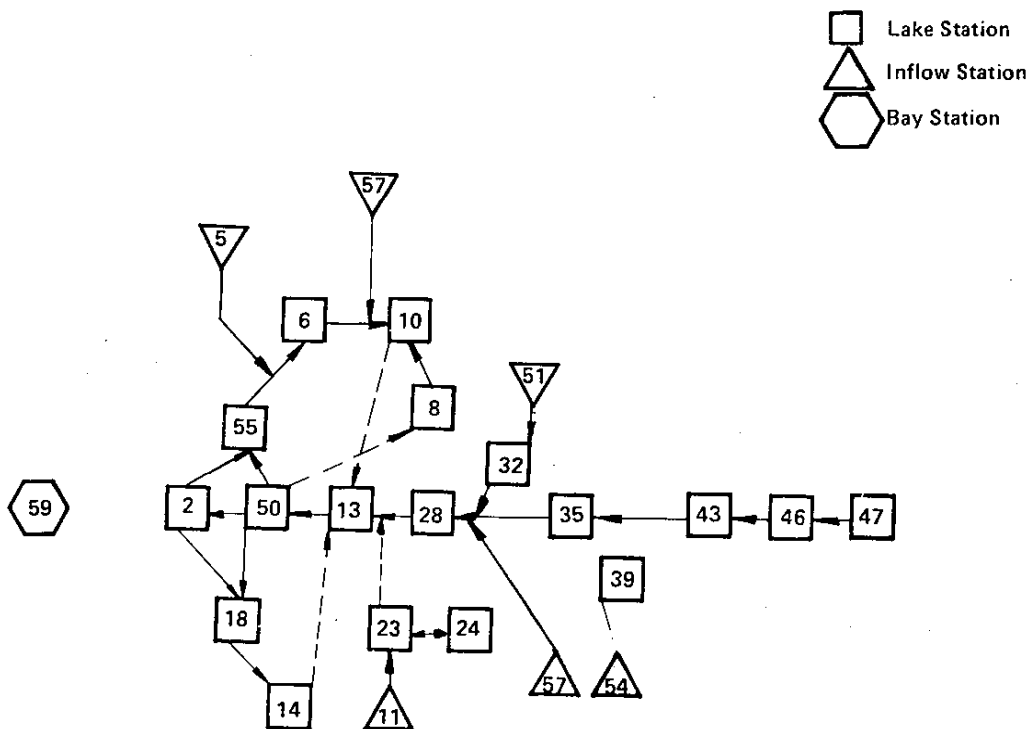

Figure 8

ROUTINE MONITORING STATION LOCATIONS AND FLOWS

The characteristics analyzed and the responsible analyst are shown below.

<u>Characteristic</u>	<u>Analyst</u>
Temperature	CH2M HILL (field)
Dissolved Oxygen	CH2M HILL (field)
pH	CH2M HILL (field)
Specific Conductance	CH2M HILL (field)
Secchi Disc Readings	CH2M HILL (field)
Turbidity	CH2M HILL
Total Solids	CH2M HILL
Suspended Solids	CH2M HILL
Settleable Solids	CH2M HILL
Total Coliforms	CH2M HILL
Fecal Coliforms	CH2M HILL
Fecal Streptococci	CH2M HILL
Kjeldahl Nitrogen	DOE
Ammonia-Nitrogen	DOE
(Nitrate + Nitrite)-Nitrogen	DOE
Total Phosphorus	DOE
Ortho-phosphorus	DOE

In addition, the Department of Ecology (DOE) collected discharge data on the Deschutes River and Percival Creek. Climatological data for the Olympia area were obtained from the National Oceanographic and Atmospheric Administration.

A subsampling of 18 stations was conducted during Lakefair (9 and 10 July). These samples were analyzed for turbidity, total coliform, fecal coliform, and fecal streptococci. Other tests included analysis of waterfowl feces for nitrogen compounds, total phosphorus, total coliform, fecal coliform, and fecal streptococci, and a die-off study of the three indicator bacteria.

EFFECTS OF FISH-REARING ACTIVITIES

Effects of fish rearing in Percival Cove were determined by measuring water quality in Percival Cove and Percival Creek and nutrients from the fish food. Data were collected from stations 23 and 24, which were located in the mouth of Percival Creek and Percival Cove, respectively. Data on fish food applications were taken from the Department of Fisheries Progress Reports No. 5 and 28 (Ref. 2, 3). Extrapolating feeding patterns from one year to another gave a reasonable estimate for nutrient input from fish food.* Fish food supplied by DOE was analyzed for total phosphorus and the nitrogen series (appendix B).

* Private communication, Stephen Evans, Department of Ecology.

SOURCES AND EFFECTS OF NUTRIENT COMPOUNDS

The routine sampling program provided excellent data to evaluate nutrients in Capitol Lake. Additional algal and zooplankton samples were collected at four stations (stations 55, 50, 28, and 24) on 13 dates (22 March, 19 April, 10 and 24 May, 7 and 21 June, 6 and 25 July, 9 and 23 August, 6 and 20 September, and 12 October). Algal samples were counted for algal identification, numbers, and biovolumes. Zooplankton samples were analyzed for identification and numbers. Chlorophyll, uncorrected for phaeophytin, was also analyzed. DOE measured the chlorophyll; Donald Nichols, Eastern Washington State University (EWSU), counted the algae; and Bill Graham, aquatic biologist, counted the zooplankton.

DATA ANALYSIS

Given several substudies within the overall study of Capitol Lake, data were divided into four banks for separate analysis. The largest bank was that of the routine monitoring at 25 stations for 17 parameters. Twenty-five dates were sampled. Three dates were sampled in July, but one of these (12 July) was dropped from most analysis to prevent biasing of data to the summer. November was also sampled three times, but all three sampling dates were included to balance the data seasonally because only one January sampling was conducted.

Station comparisons of the yearlong data were made by analysis of variance followed by use of Duncan's new multiple-range test on an *a posteriori* basis (Ref. 4, 5). Analysis of variance is a widely used statistical test that tells if the parameters measured (e.g., total coliform or fecal coliform) are statistically of the same group or different groups. Because the purpose of such a large number of stations was to determine if pipes and other inflows represented point sources of pollutants to the lake, the data were analyzed for statistically significant variation between the stations. If the analysis of variance was insignificant, no point source was indicated.

If, on the other hand, the result was significant (i.e., unlikely to occur by chance alone), a second test, Duncan's new multiple-range test, was applied to define which stations were in the same subgroup and which were in separate subgroups. The nature of the test allows some stations to belong to two or more subgroups if the stations are in areas where the two subgroups overlap. The investigator then decides the ecological significance of these groupings. Selected subsets of these data were analyzed by correlation analysis. The statistical analysis of these data is given in appendix C.

A significant level of $P=.05$ was used throughout this study. This means the observed distributions of groups would not be expected to occur on a random basis more than one time out of twenty.

The second set of data was the algal, chlorophyll, and zooplankton data coupled with relevant chemical, physical, and meteorological data. When algal and zooplankton samples were not collected on the same day as

chemical samples, the results of chemical samples were interpolated, assuming a linear change with time, to the algal-zooplankton sampling date. Such an interpolation took place using chemical-physical data on 4 October and 18 October for the algal-zooplankton data collected on 11 October. On two other dates, 25 July and 20 September, biotic and chemical-physical samples were not collected concurrently, but flushing of the lake prevented interpolation of data. On these two days, the chemical-physical data preceding flushing were used.

The second set of data was also analyzed for differences among stations for total algal numbers, total algal volumes, zooplankton numbers per liter and number per meter surface area, and chlorophyll. Correlations were run among these parameters and selected physical-chemical parameters (discharge, inorganic nitrogen loading, ortho-phosphate loading, total phosphate, ortho-phosphate, nitrate-nitrogen, ammonia-nitrogen, and Kjeldahl nitrogen). Biological data from the swimming area (station 55) were not included in correlations with discharge or nutrient loadings because these parameters were uncertain for that station.

The Lakefair data were analyzed separately using analysis of variance followed by Duncan's new multiple-range test. This analysis is in appendix C.

The data from the synoptics were also analyzed separately using analysis of variance and Duncan's test. This analysis also is included in appendix C.

Two conventions were adopted for data reported as less than or more than a given value. Data reported as "more than" (>) were rounded to the next highest single significant figure (i.e., >2,400 = 3,000). Data reported as "less than" (<) were set equal to the value midway between the detection limit and zero (i.e., <.02 = .01).

INDICATOR BACTERIA IN CAPITOL LAKE

The Significance of Indicator Bacteria

Three bacterial groups have been used to indicate fecal pollution of waters. These groups are total coliform bacteria, fecal coliforms, and fecal streptococci. The total coliforms, although widely used, are in reality a poor indicator of fecal pollution. This is because they are a heterogeneous group of bacteria that are widespread and not always typical of intestinal origins (Ref. 6, 7), and they include the *Aerogenes* group, which can grow in freshwater (Ref. 8).

Fecal coliforms are considered a better indicator of intestinal pollution because they originate almost exclusively in warmblooded intestines. This group usually comprises about 14 percent of the total coliform group, but the percentage can vary from 0.4 to 45 percent (Ref. 9). The group is found in soils polluted with fecal waste but is not abundant in nonpolluted soil (Ref. 10). Runoff from polluted soils also carries these bacteria (Ref. 11). The main shortcoming to using fecal coliforms as an indicator is the inability to differentiate between animal and human fecal pollution.

Fecal streptococci, the third group of bacteria used to indicate fecal pollution, originate in warmblooded intestines and do not multiply in open water (Ref. 12). They also are found in both human and nonhuman intestines.

Geldreich *et al.* (Ref. 13) first proposed that the ratio of fecal coliform to fecal streptococci (FC:FS) be used to distinguish human sources of fecal pollution from nonhuman sources. An FC:FS ratio of 4:1 or more is typical of human sewage, while ratios less than 0.7:1 are typical of nonhuman fecal pollution. This is clearly seen in table 2. This apparently easy means of differentiating between types of sources quickly found wide acceptance (Ref. 14, 15, 16), but studies on the different survival rates of the two bacterial groups quickly restricted the use of the ratio. Fecal coliform bacteria die off faster than fecal streptococci, resulting in changes in the bacterial ratios. A ratio of 4.2 could change to 2.2 in 4 days, and a ratio of 0.25 could reach 2.0 in the same period (Ref. 17). This has led to two restrictions on the use of this indicator. First, some authors believe the FC:FS ratio is useful only if taken within 24 hours of excretion from the host (Ref. 18). Second, the ratios should be interpreted in light of the different die-off rates (Ref. 19). If the ratio starts at 4 and decreases, human sources are indicated; if it starts at less than 4 and increases, nonhuman sources can be inferred. Other possibilities leave uncertain results. The possible interpretations are shown below.

<u>Initial FC:FS Ratio</u>	<u>Change With Time</u>	<u>Indicated Source</u>
>4	Decrease	Human
>4	Increase	Uncertain
<.7	Decrease	Uncertain
<.7	Increase	Nonhuman

These ratios apply only to pollution from either an all human or all nonhuman source. Mixed sources will produce altered ratios that reflect the magnitude of each source. A fecal pollution mixture of 33 percent human origin and 67 percent nonhuman origin would have an FC:FS ratio of 2.7. This mixing effect has been documented by Feachem (Ref. 20).

All three bacterial indicators and the FC:FS ratio have been used in this study to decipher the complex picture of indicator bacteria in Capitol Lake. In addition, a die-off study was conducted to see if observed ratios changed according to the scheme outlined above.

Indicator Bacteria in Capitol Lake During 1977

Total Coliforms

Analysis of variance and Duncan's test on the indicator bacteria gave five overlapping statistical groups of stations according to their year-long total coliform densities. This statistical grouping shows stations 5 and 51 (storm sewer pipes) and 46 and 47 (the Deschutes River and south basin stations) as having significantly more total coliforms than the others. Stations 5 and 51, while discharging close to stations 6 and 32, respectively, did not significantly increase the two lake stations' bacterial densities. This is attributed to low flow from these two sources. Stations 46 and 47 were found to be more important because they reflect concentrations of bacteria in the Deschutes River and would contribute larger amounts of bacteria to the lake because of the river's large discharge.

The relationship between total coliform and the river discharge is shown in figure 9. Peak coliform densities occurred during the summer and fall (July through November) and were not highly related to river discharge. The combination of discharges and density gave maximum loading of total coliforms to the lake in July and August (because of high densities) and in October (because of high flows). Station 47 densities are similar to the total coliform densities at the DOE water quality station at Tumwater (river mile .4), which indicates the existence of a source above Tumwater.

Lake station densities fluctuated a great deal and were not in accord with loading rates from the river (figure 10). In the south and middle basins, peak densities occurred during the period from July through October. The north basin had erratic peaks throughout the year, indicating other possible sources for that basin.

Table 2. FECAL COLIFORM AND FECAL STREPTOCOCCUS DENSITIES
FROM VARIOUS SOURCES

Bacterial Densities and Fecal Streptococcus
Distributions in Warmblooded Animal Feces^a

Fecal Source	No. of Samples	Density (median values)		Ratio FC:FS
		Fecal Coliforms	Fecal Streptococci	
Human	43	13,000,000	3,000,000	4.4
Animal Pets				
Cat	19	7,900,000	27,000,000	0.3
Dog	24	23,000,000	980,000,000	0.02
Rodents	24	160,000	4,600,000	0.04
Livestock				
Cow	11	230,000	1,300,000	0.2
Pig	11	3,300,000	84,000,000	0.04
Sheep	10	16,000,000	38,000,000	0.4
Poultry				
Duck	8	33,000,000	54,000,000	0.6
Chicken	10	1,300,000	3,400,000	0.4
Turkey	10	290,000	2,800,000	0.1

Bacterial Densities for Meat Packing House and Dairy
Effluents as Related to Farm Animal Fecal Contamination^b

Source	Bacterial Density per 100 ml Effluent or 1 gm Feces		Ratio FC:FS
	Fecal Coliforms	Fecal Streptococci	
Waste effluent			
Meat packing	3,300,000	4,700,000	0.7
Cattle truck wash	3,300,000	40,000,000	0.1
Prison dairy	1,420,000	3,420,000	0.4
Livestock			
Sheep	16,000,000	38,000,000	0.4
Cow	230,000	1,300,000	0.2
Pig	3,300,000	84,000,000	0.4
Poultry			
Duck	33,000,000	54,000,000	0.6
Chicken	1,000,000	3,400,000	0.4
Turkey	290,000	2,800,000	0.1

Table 2. (Continued)

Bacterial Densities in Various
Domestic Sewages and Human Feces^b

Sewage	Bacterial Density per 100 ml		Ratio FC:FS
	Fecal Coliforms	Fecal Streptococci	
Residential "A"	17,200,000	4,000,000	4.3
Residential "B"	10,900,000	2,470,000	4.4
Residential "C"	340,000	64,000	5.3
Residential "D"	6,300,000	1,720,000	8.6
Human Feces	13,000,000*	3,000,000*	4.4

* Density per gram.

Bacterial Densities for Separate Stormwater Discharge Systems
as Related to Animal Pets and Rodent Fecal Contamination^b

Source	Bacterial Density per 100 ml Effluent or 1 gm Feces		Ratio FC:FS
	Fecal Coliforms	Fecal Streptococci	
Storm water Discharge			
Business district	13,000	51,000	0.26
Suburban streets	6,400	150,000	0.04
City park	1,900	27,000	0.70
Agricultural	2,700	58,000	0.05
Animal Pets			
Cat	7,900,000	27,000,000	0.30
Dog	23,000,000	980,000,000	0.02
Rodents			
Rat	330,000	7,700,000	0.04
Chipmunk	150,000	6,000,000	0.03
Rabbit	20	47,000	0.0004

^a From Geldreich and Kenner, 1969.

^b From Geldreich, 1967.

The major source of total coliforms appears to be the Deschutes River. The densities of bacteria in the lake generally decrease with increasing distance from the river mouth (figure 11). The Deschutes River contributes 12.7 times more bacteria on an annual basis than does Percival Creek.

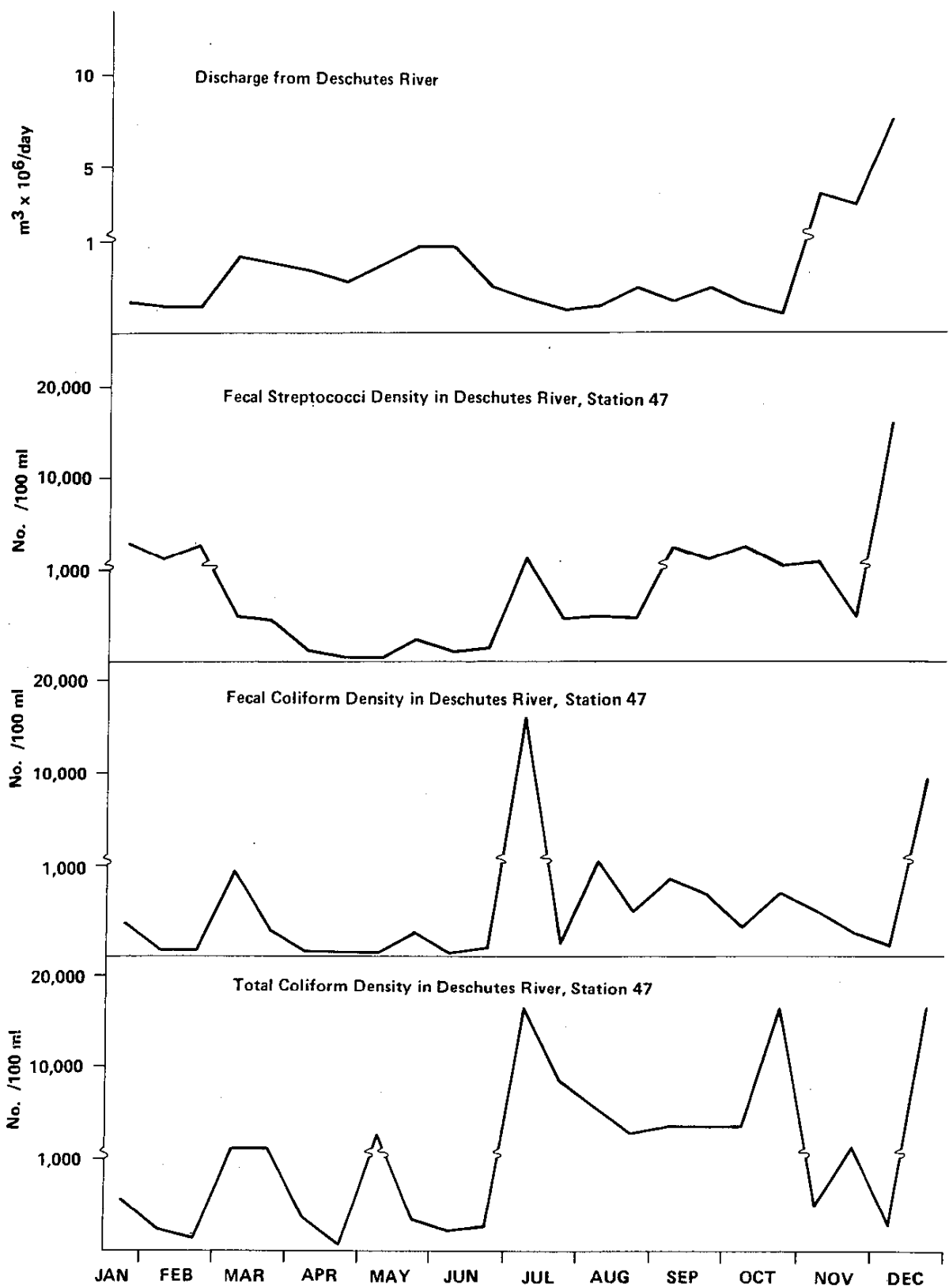

Figure 9
 DESCHUTES RIVER DISCHARGE AND INDICATOR BACTERIA DENSITIES

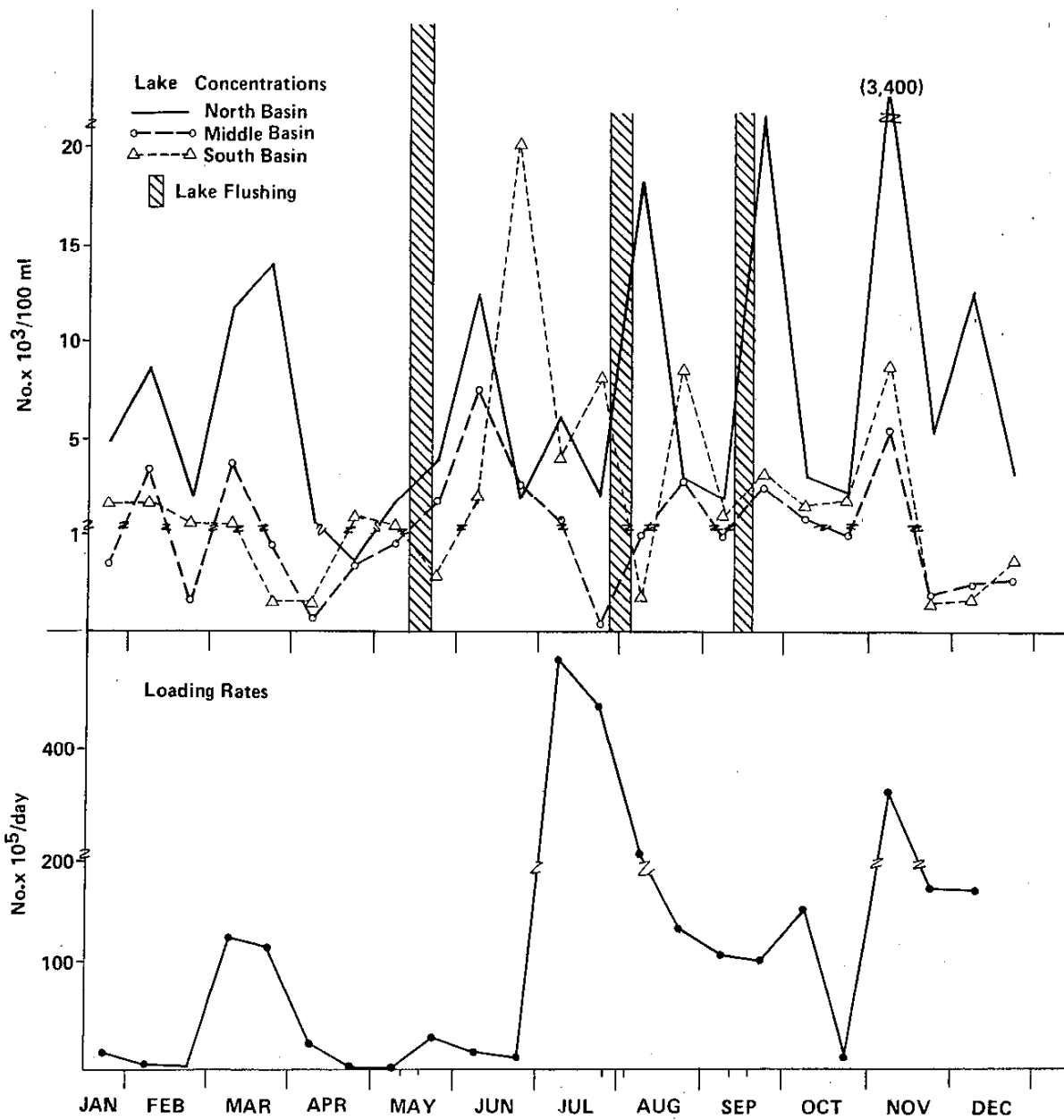

Figure 10

TOTAL COLIFORM LOADING RATES AND LAKE CONCENTRATIONS

MEAN TOTAL COLIFORM CONCENTRATION (MPN/100 ml)

470

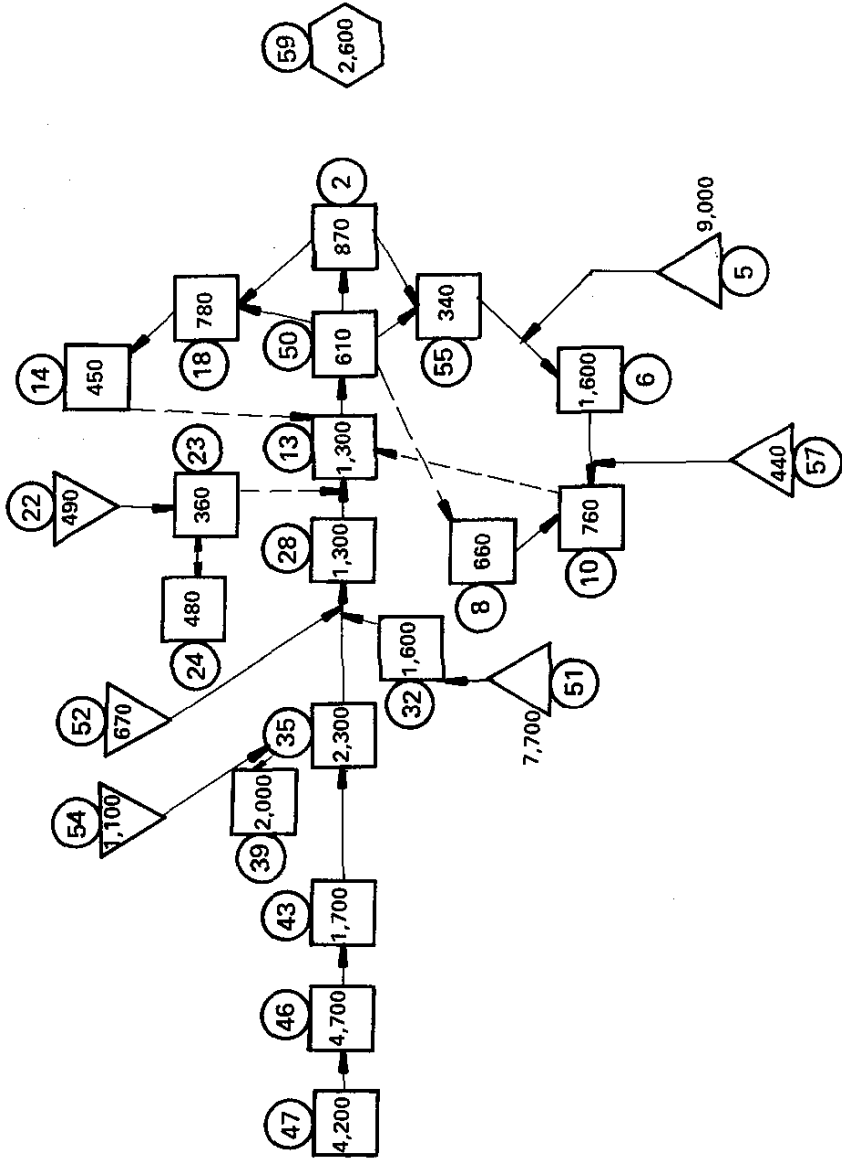

Figure 11
DISTRIBUTION OF MEAN TOTAL COLIFORM CONCENTRATIONS
BY STATION

When the lake was flushed with saltwater during the summer, total coliforms and specific conductivity displayed a slightly negative, statistically significant correlation ($r = -.07$, $n = 151$), which indicates flushing as having only minor effects on total coliform densities. Attempts to lessen total coliform densities in the lake are best directed upstream past station 47 on the Deschutes River. However, the densities in the lake are not entirely a function of river discharge, but result from a combination of discharge and bacterial density in the river, altered die-off rates, and smaller inputs from nonpoint (runoff and waterfowl) and point sources.

Fecal Coliforms

Fecal coliforms are a better indicator of fecal pollution than are total coliforms. The statistical analysis of these data resulted in two subgroups, with station 5 (storm sewer) having densities significantly higher than those of the other stations. Peak fecal coliform (FC) densities occurred mostly during the period from August through November, but densities fluctuated in the different basins throughout the year (figure 12). Maximum inputs from the Deschutes River occurred during early July as a result of very high densities in the river. Secondary peaks occurred in March and November. As water flows through the lake, there is a general decrease in FC densities (figure 13), which indicates that the Deschutes River is a major contributor of FC to the lake. The effects of pipe inflow can be seen by the higher densities at stations 32 and 6, which receive FC from stations 51 and 5, respectively.

The July peak of FC loading from the Deschutes River is the result primarily of higher FC densities (figure 9), as is the March peak. The November peak resulted from higher inflows and higher densities.

Discharge is not highly correlated with lake station densities ($r = .02$, $n = 374$), and it is apparent from figure 12 that the densities of FC in the lake basins do not closely follow loading by the Deschutes River. The three basins only roughly exhibit the same seasonal patterns. All these facts point to various sources of fecal coliforms for each basin, with the Deschutes River contributing high background densities but other sources influencing the pattern across the lake.

Fecal Streptococci

Fecal streptococci (FS) show three overlapping statistically significant subgroups, with station 51 (storm sewer) having the highest densities, followed by stations 5, 14, 43, and 47. Stations 43 and 47 are at the mouth of the middle basin and on the Deschutes River, respectively. The next highest station is 46, which lies between these two stations. Stations 43, 46, and 47 again show the dominant effect of the Deschutes River as a source of bacteria. Stations 51 and 5 are pipes that show very high densities. Station 14 is in the north basin near an area called "Coot Park" by the field personnel (Charles Lindberg) because of its high coot populations.

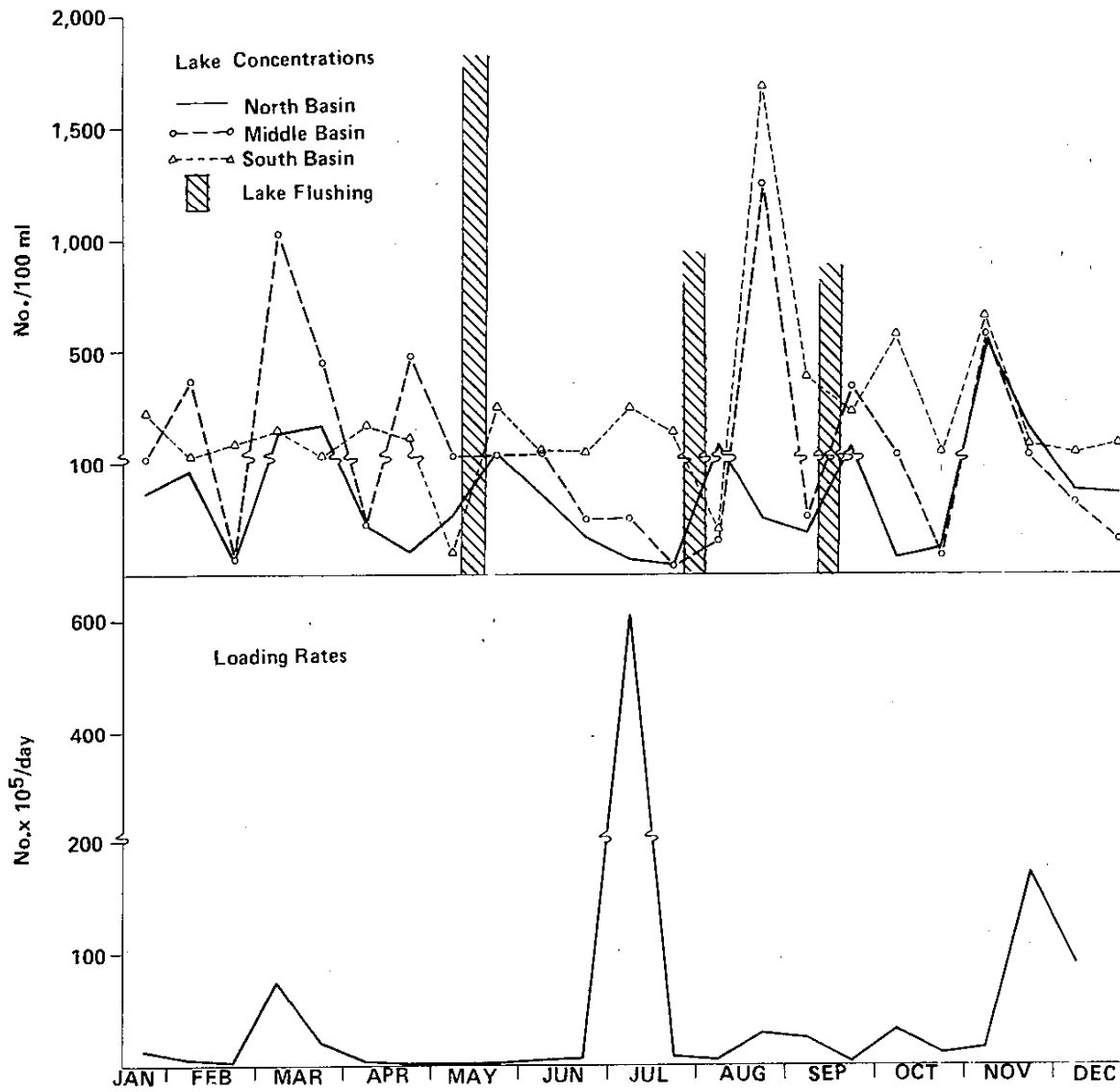

Figure 12
 FECAL COLIFORM LOADING RATES AND LAKE CONCENTRATIONS

59 Mean Fecal Coliform Concentration (MPN/100 ml)

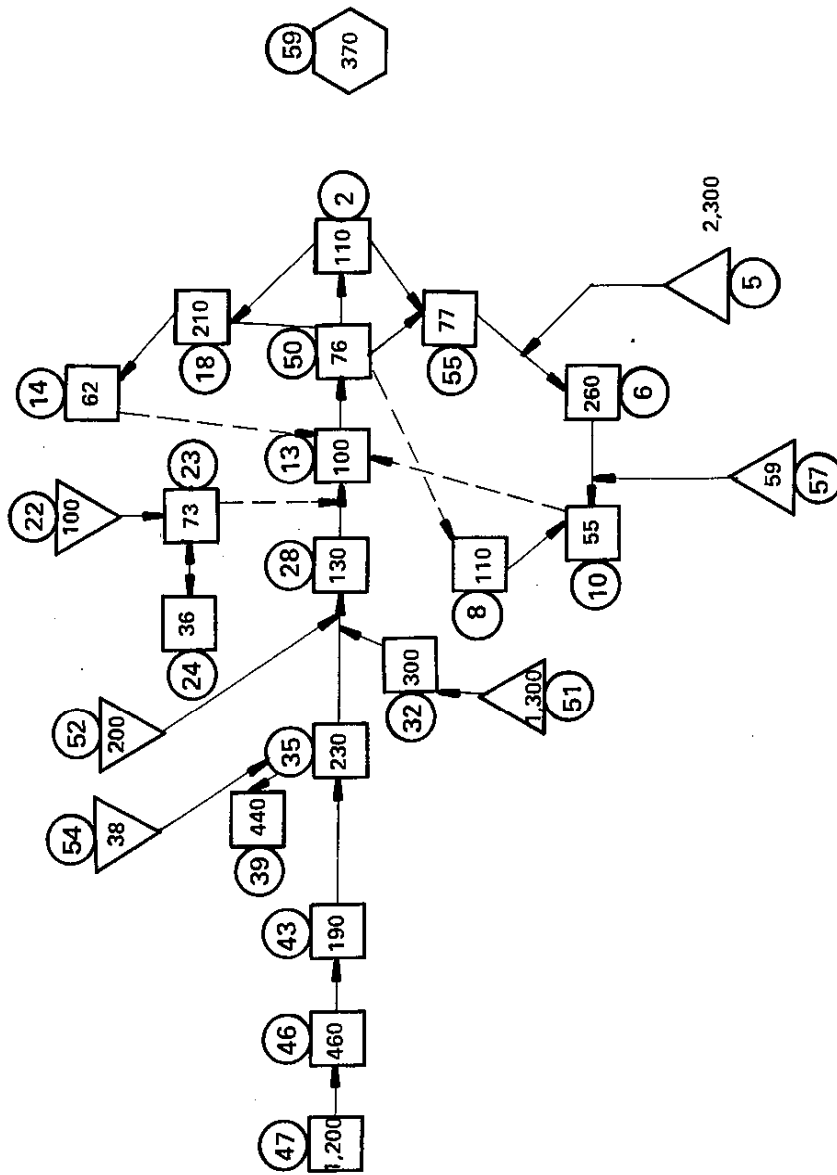

Figure 13
DISTRIBUTION OF MEAN FECAL COLIFORM CONCENTRATION
BY STATION

FS densities are highest in all the basins from July onward (figure 14). These increased densities precede the November-December peak loading by the Deschutes River. The peak loading is the result of higher densities and higher discharge during that period (figure 9). Correlation of lake FS densities with river discharge is significant although not high ($r = .10$, $n = 374$), indicating the importance of river discharge on FS densities. Correlation with specific conductivity during the summer is very low ($r = .06$, $n = 151$), indicating the negligible effect of flushing on fecal streptococcus densities.

FS densities also decrease generally as water flows through the lake (figure 15), again indicating the importance of input by the Deschutes River. A local high density occurs at station 14, as mentioned earlier.

FC:FS Ratios

Fecal coliform to fecal streptococcus ratios are analyzed in this section in an attempt to identify sources of fecal pollution. However, their usefulness for this purpose is limited by differences in die-off rates and by the mixture of human and nonhuman fecal sources in the lake.

Statistically, all the stations belong to the same FC:FS group. Several stations within this group, however, show fecal coliform to fecal streptococcus (FC:FS) ratios that average over 4. Stations 10, 13, 14, 18, 35, 46, 52, and 54 have average ratios between 4.1 and 6.0. Because the time the bacteria enter the lake is uncertain and because their die-off rates are unknown, we cannot positively say that these ratios indicate human fecal pollution. The over-4 ratio of several stations in the north basin implies an occasional human fecal source in this basin (figure 16).

Over the study period, the FC:FS ratio changed considerably (figure 17). The average ratio of all the lake stations exceeded 4 on 18 January, 19 April, 3 May, 24 May, and 7 June. The variation of these averages was very high, indicating the heterogeneity of the different stations. All the basins also showed peak ratios during this time (figure 17). These very high ratios indicate a 3-month-long period of possible human fecal contamination. Given the distribution of ratios over 4 for each station over time (figure 18), the period from January through early July is implicated as a time of human fecal pollution. The source of this pollution appears to be within the lake itself because inflow pipes and the Deschutes River and Percival Creek do not exceed a ratio of 4 as often as the lake stations. The source of the fecal pollution might be the submerged pipes that could not be sampled directly. Station 52, which empties into the middle basin, is the pipe station that most frequently exceeds a ratio of 4 during the period of January through March. Several pipe stations and the Deschutes River show high ratios to the end of July (22 July), but only two lake stations show high ratios after 7 June.

The highest frequency of stations having an FC:FS ratio over 4 is in the north basin, then at station 46 in the south basin, and, finally, in

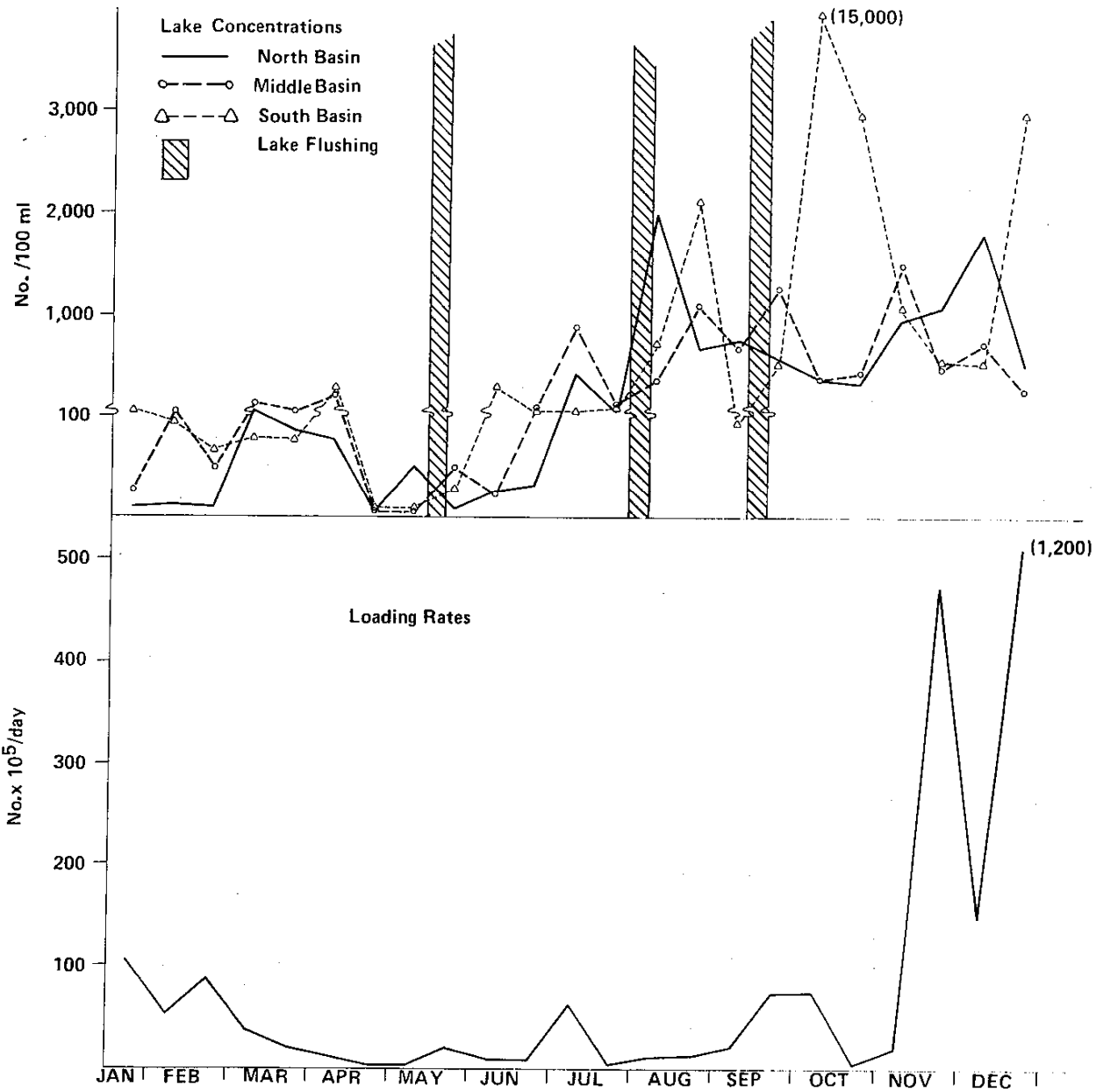

Figure 14
 FECAL STREPTOCOCCI LOADING RATES AND LAKE CONCENTRATIONS

Mean Fecal Streptococci
Concentration (MPN/100 ml)

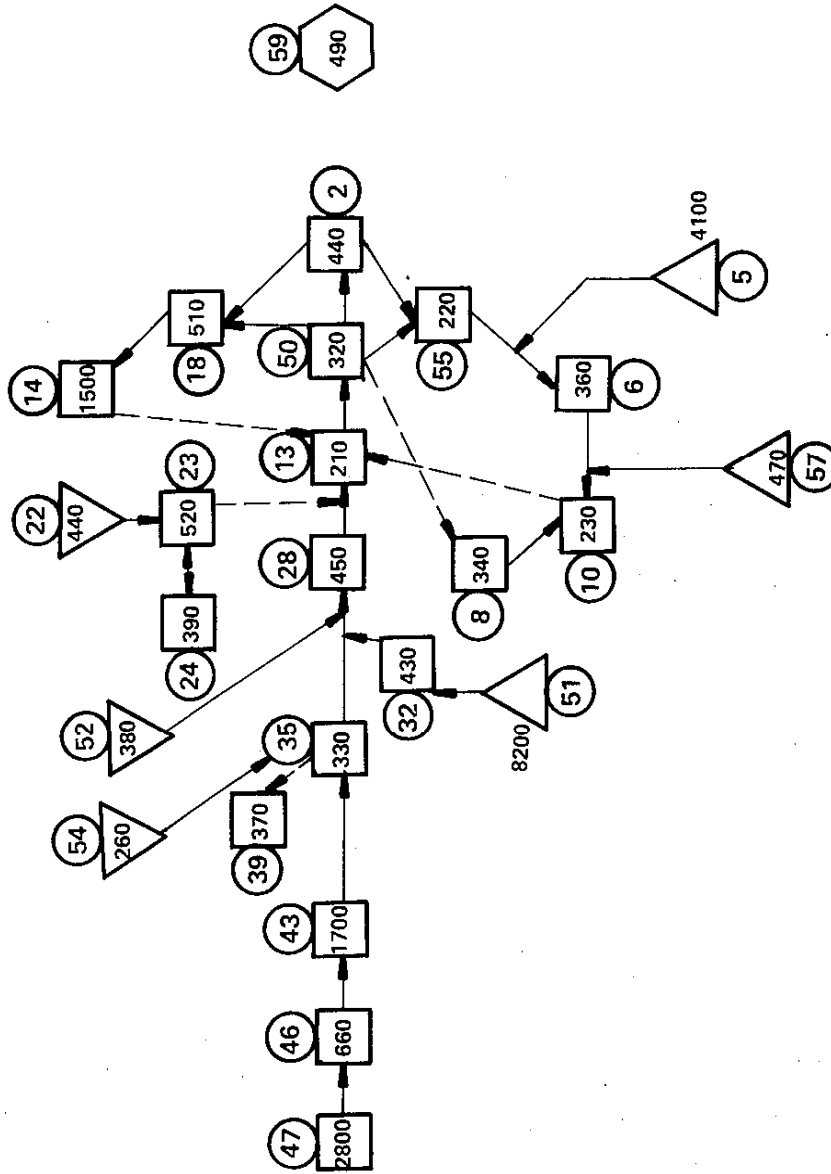

Figure 15
DISTRIBUTION OF MEAN FECAL STREPTOCOCCI CONCENTRATION
BY STATION

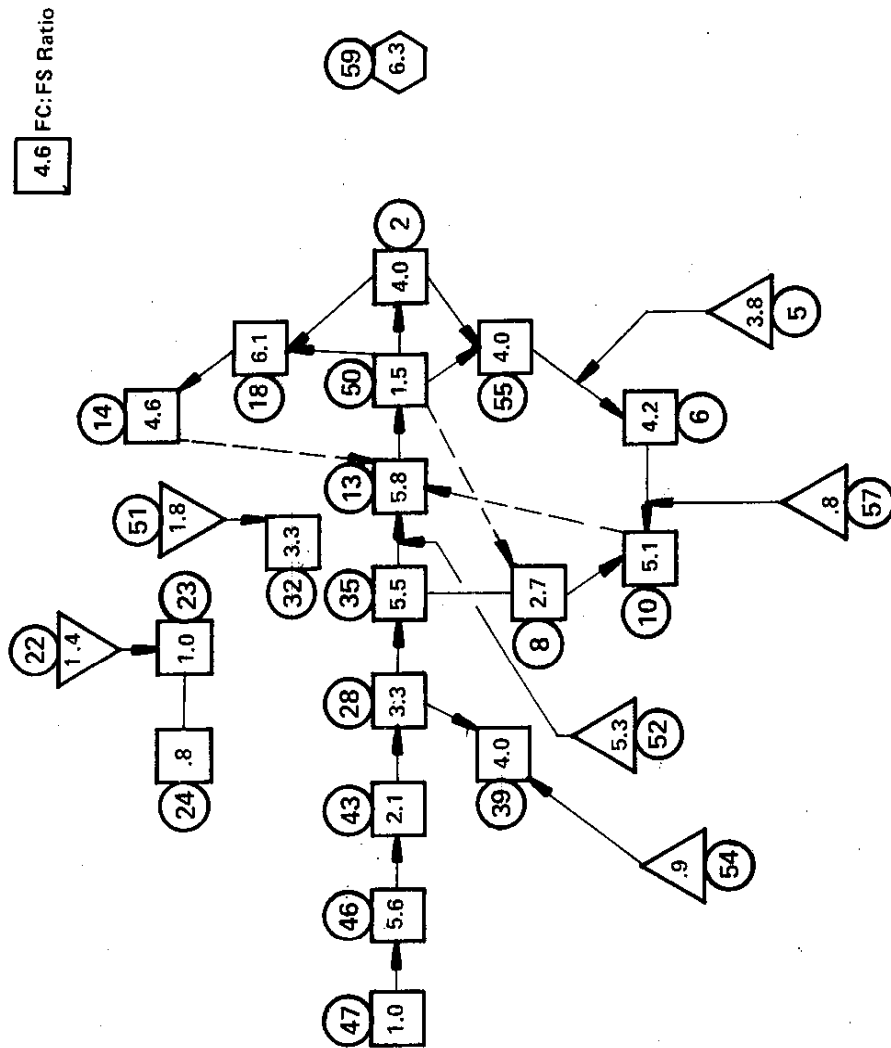

Figure 16
MEAN DISTRIBUTION OF FC:FS RATIOS BY STATION

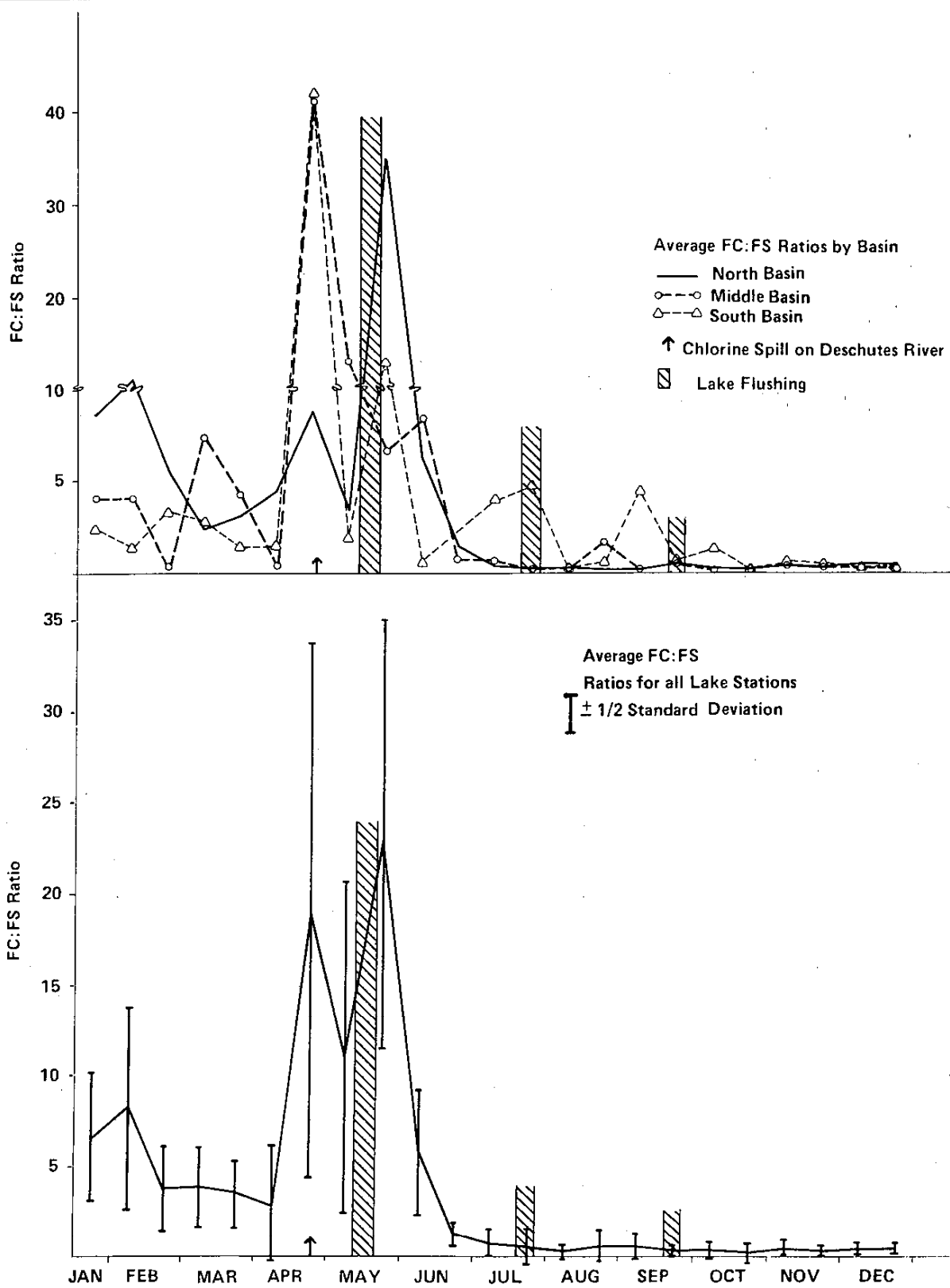

Figure 17
LAKE AND BASIN FC:FS RATIOS, 1977

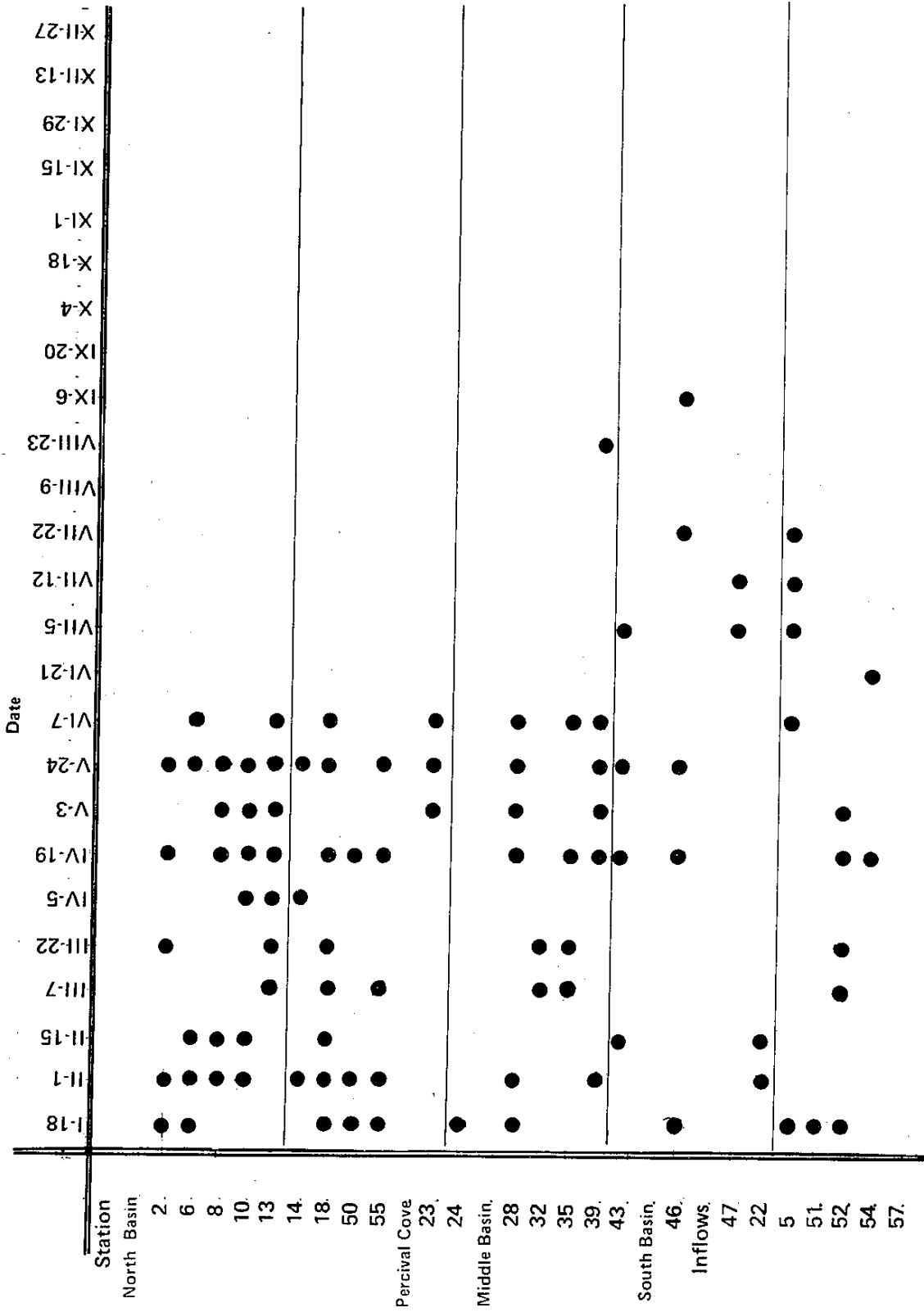

Figure 18
OCCURRENCE OF FC:FS RATIOS GREATER THAN 4:1

the middle basin. This implies fecal pollution of human origin entering the lake at several spots, with the Deschutes River not being a major source of this pollution.

This pattern may, however, be misleading because the ratio of FC:FS depends on all the sources of fecal pollution. A predominance of fecal pollution from nonhuman sources would easily overshadow a smaller volume of human fecal pollution when just the FC:FS ratio is available. A major nonhuman fecal source of pollution to Capitol Lake is waterfowl. Large populations of waterfowl were repeatedly mentioned in the field notes, mostly in the north basin. Also, a group of about 20 geese resides above station 47 on the Deschutes River. Table 3 indicates the high excretion rate of indicator bacteria from waterfowl. The abundant bird populations in Capitol Lake could easily supply enough input of low-FC:FS fecal pollution to overshadow the inputs of high-FC:FS pollution by a smaller source of human fecal pollution. The estimates in table 3, while appearing high, are in actuality probably low. The only equivalent information on coliform excretion rates is 3.3×10^{10} total coliforms per duck per year (Ref. 21).

Table 3. CALCULATION OF INDICATOR BACTERIA
EXCRETION RATES BY WATERFOWL

Densities of Indicator Bacteria^a

	No./gm Wet Weight Feces ($\times 10^6$)	No./kg N ($\times 10^{11}$)	No. kg P ($\times 10^{12}$)
Total Coliforms	27.80 \pm 26.30	49.5	45.6
Fecal Coliforms	18.75 \pm 30.50	33.4	30.7
Fecal Streptococci	2.25 \pm 23.20	4.01	3.69

Excretion Rate of N and P^b (kg/bird/yr)

Nitrogen	.48 - .95
Phosphorus	.09 - .18

Calculated Excretion Rates of
Indicator Bacteria^c (org/bird/yr)

Total Coliform	4.84 \pm 2.44 $\times 10^{12}$
Fecal Coliform	3.26 \pm 1.64 $\times 10^{12}$
Fecal Streptococci	3.92 \pm 1.98 $\times 10^{11}$

^a Mean \pm standard deviation, n = 3.

^b From Bezonik, 1974.

^c Mean \pm standard deviation calculated from mean number organisms/kg N or P for each range of N and P excretion rate.

A possible explanation for the observed pattern of FC:FS ratio is analogous to Feachem's findings (Ref. 22). During the periods of low ratios, fecal contamination by waterfowl is dominant and overshadows the smaller contamination by a human source. This is why the ratios are low when numbers of waterfowl are high. But when waterfowl are not present in large numbers or interactions of waterfowl and rainfall reduce the input of bacteria originating from runoff contaminated by bird feces, the ratio rises because human fecal pollution becomes dominant. The amount of bacteria is slight, however, because densities are low. The Deschutes River (station 47) often exceeds class A total coliform standards but is usually within the standards when the FC:FS ratio is high. No systematic bird counts are available to further evaluate this hypothesis.

To determine the origin of the pollutants in the pipes discharging into the lake, the measured concentrations of indicator bacteria in these pipes was compared to those of combined sewage overflow. The Capitol Lake pipe stations were found to have much lower bacterial densities than does combined sewage. Average total coliform densities in Seattle area sewers (Ref. 23) have been measured at 2,600,000 per 100 ml; fecal coliforms were 270,000 per 100 ml; and fecal streptococci were 36,000 per 100 ml. These levels are one to two orders of magnitude higher than average densities found in the Capitol Lake pipes. This indicates that none of these pipes is a direct domestic or combined sewage outfall. It is more likely that their bacterial content originates from leaky sewer mains nearby and is diluted by other water sources (storm runoff, ground-water, or lake water) or that densities are decreased tremendously by die-off. The bacterial densities of the pipes at stations 5 and 52 are not high enough to significantly alter the lake water at existing discharge volumes. The combined effects of the several submerged pipes on the west side of the north basin might account for the high FC:FS ratios at stations 18 and 13.

Ratio changes resulting from the differential die-off rates of fecal coliform and fecal streptococci were also assessed in an attempt to identify types of sources within the lake. In this analysis, water samples were collected on 27 December 1977, incubated at 20°C, and analyzed for ratios of fecal coliform and fecal streptococci. The results are shown in figure 19.

Immediately apparent is the low starting ratio for all but station 28. All these stations (except 28) increase on the second day. Patterns after the second day vary. Station 28 starts at .9 then decreases, but increases and stays at 1 after day 3. None of these stations shows a pattern indicative of human fecal pollution. Most stations suggest animal sources, and station 28 gives an uncertain pattern. Unfortunately, this test was not run on samples taken during the period when ratios were high, so that the sources of pollution that causes high ratios remain unidentified.

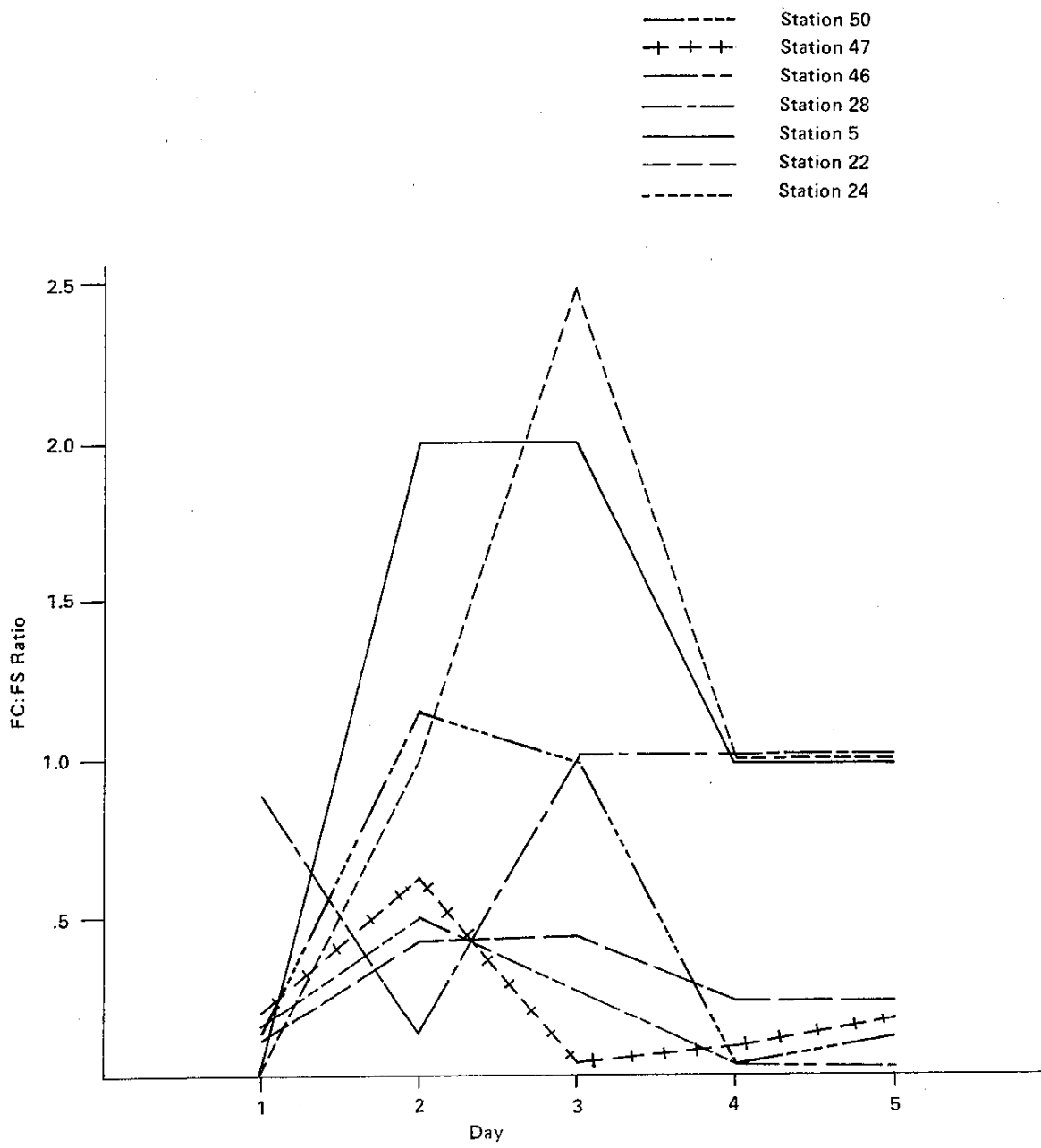

Figure 19
 CHANGES IN FC:FS RATIOS WITH TIME

Bacterial Indicators During Lakefair

Samples were taken at several stations on the 9th and 10th of July, during Lakefair. Analysis of variance showed no significant differences between stations during this period for total coliforms, fecal streptococci, the FC:FS ratio, or turbidity. Fecal coliforms were significantly higher at station 5 than at the other stations, but this is usually the case at that station.

The typical pattern of high total and fecal coliforms in the south basin decreasing to the north basin was also seen on these sampling days. Higher fecal streptococci were found around the east side of the north basin (stations 6, 8, and 10), which could be due to birds reported in that region or to inputs from station 5 (figure 20).

Mean numbers of indicator bacteria have been plotted in figure 21 for the north basin. Total coliforms undergo a dramatic increase in the lake right after the fair; fecal coliforms increased during the fair. Although the fair is initially implicated as increasing both total coliform and fecal coliform, further analysis shows that a large impulse of all types of bacteria occurred in the south basin on 5 July, which would also increase bacteria in the north basin in the following week. The cause of this impulse is unknown.

Synoptic Surveys and Bacteria Indicators

No comparisons of the synoptic survey stations were significant (figure 22). This is due mainly to relatively few samples (four for total coliform and turbidity, two for fecal coliform and fecal streptococci) spread across different seasons, which results in high variation at each station.

Total coliform and turbidity were the only two parameters measured during the 6 January survey. Total coliforms generally decreased as water flowed through the lake, with peaks at stations 47 (Deschutes River), 30, 36, and 25 (west side of middle basin), 28 (middle of middle basin), and 13 (mouth of north basin at connection with middle basin). Possible pollution sources on the west side of the middle basin and on the Deschutes River between stations 47 and 48 are indicated for this date.

On 6 May total coliforms were high along the southwest corner of the middle basin (stations 39, 40, and 41), and the entire south end of the middle basin had higher counts than most other areas.

On 27 September the usual pattern of high coliform densities in the Deschutes River diminishing with flow through the lake was seen for total coliforms. A similar pattern was seen for fecal streptococci, with higher densities at stations 14 and 55 (north basin near "Coot Park" and the swimming area, respectively), 39 (south corner of middle basin), and 27A and 28 (middle of middle basin). Concentrations in storm sewers 54 and 52 were also high. Fecal coliforms follow a pattern very similar to that of total coliforms, with a maximum at station 47.

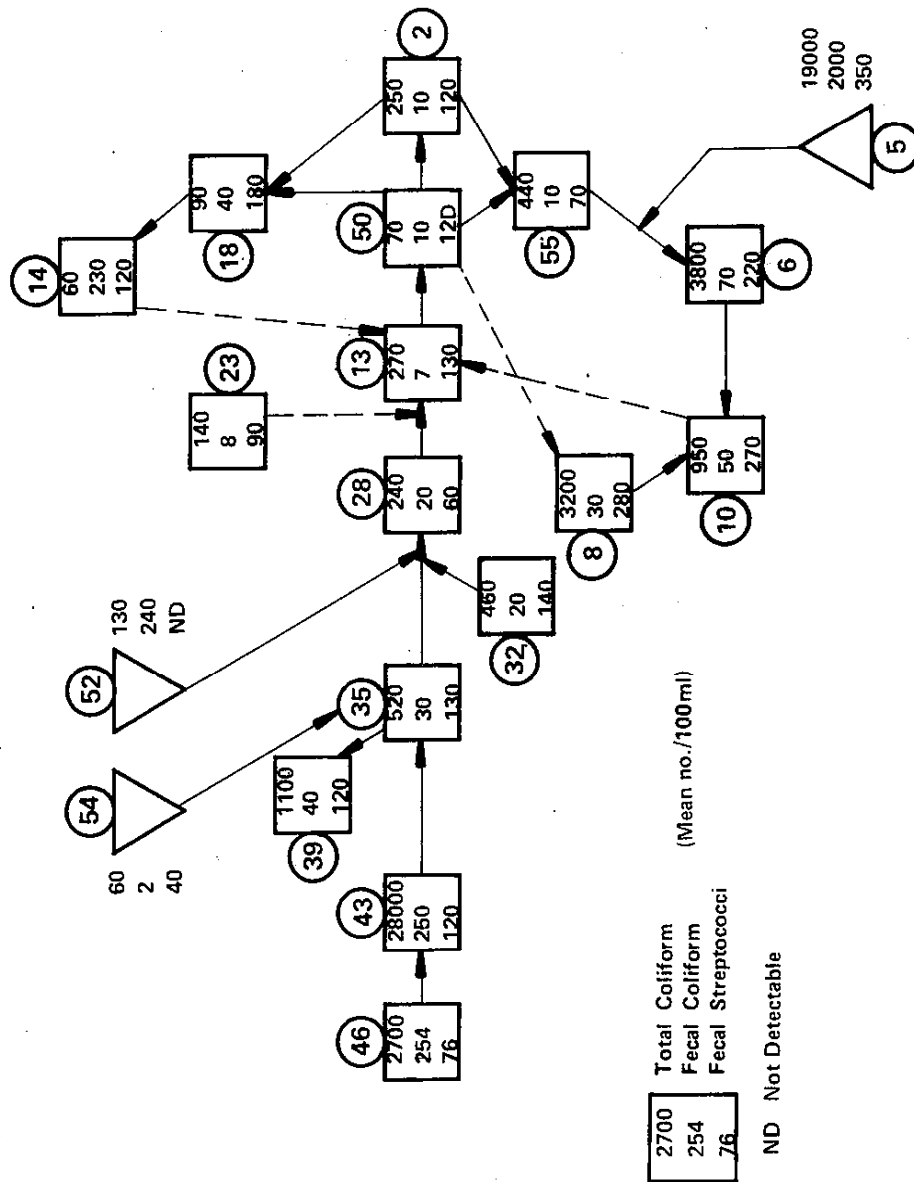

Figure 20
 DISTRIBUTION OF INDICATOR BACTERIA DENSITIES DURING LAKEFAIR

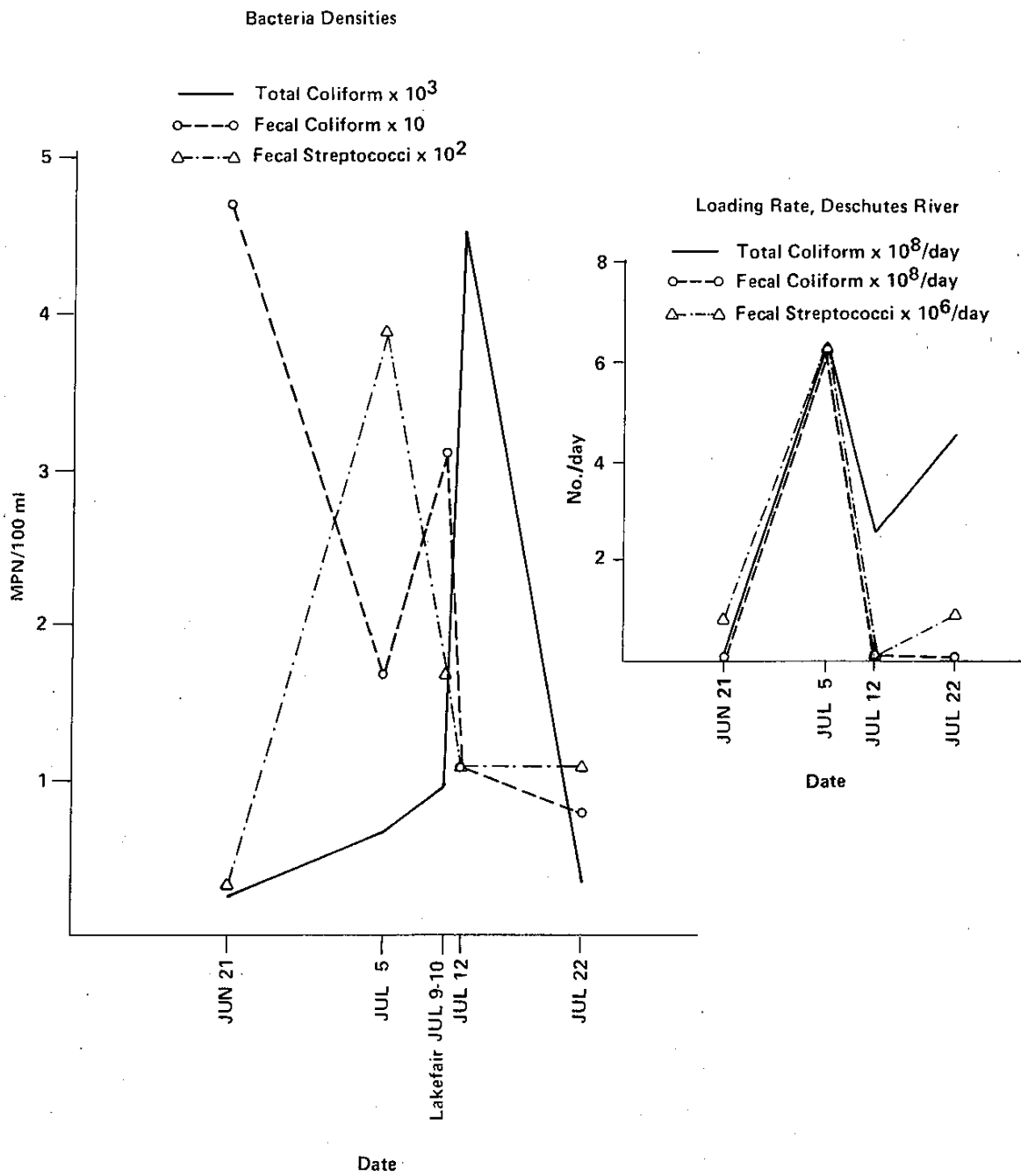

Figure 21
BACTERIA DENSITY CHANGES IN NORTH BASIN DURING LAKEFAIR

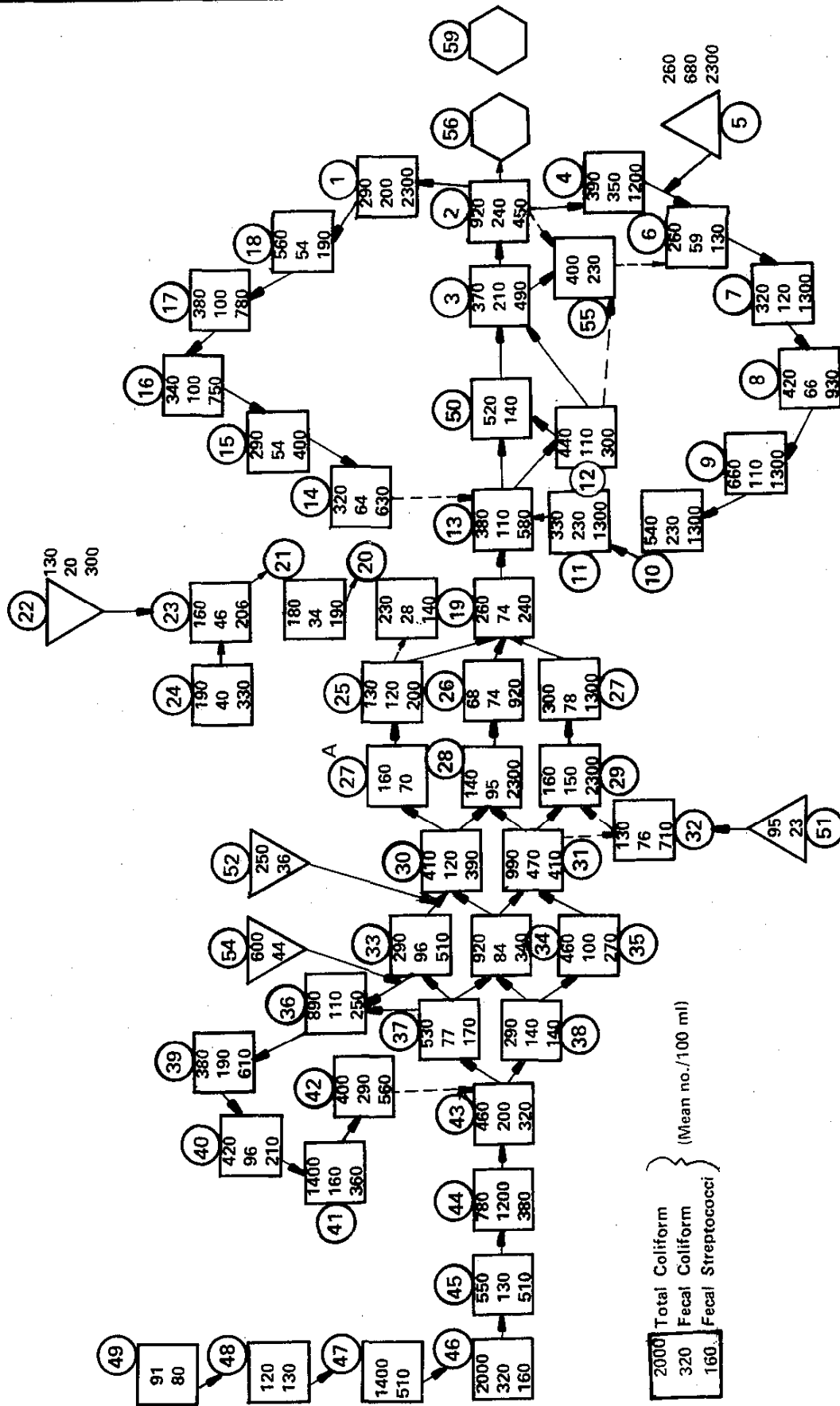

Figure 22
 DISTRIBUTION OF INDICATOR BACTERIA
 DENSITIES DURING SYNOPTIC SURVEYS

The FC:FS ratios are all very low (maximum = 1.3, station 42), giving no indication of human fecal contamination. This survey took place during a rainstorm when many birds were present, which could account for the high fecal streptococci areas.

The last synoptic survey was conducted on 4 December 1977. During this period total coliforms increased as the river passed station 47. Total coliforms were high in the south corner and end of the middle basin, and decreased to the north end of the basin. Counts of total coliforms increased again in the north basin, especially around the outlet gates. Counts in the middle basin were higher around the edges than in the middle. Inflow pipes, except for station 5, had low counts. Fecal coliforms were low in all pipes except 5, and increased as the Deschutes flowed past 47 and again at 44. In the north basin, the swimming area and outlet gates region were high, as was the southeast area. Fecal streptococci were very high (often exceeding 240,000) at all stations on the Deschutes River, the south basin, and the south end of the middle basin. The east area of the north basin was also high, but not as high as in the southern region of the middle basin. Inflowing pipes were all low except for station 5. FC:FS ratios were all very low during the December synoptic survey.

Sources of Indicator Bacteria

Results of the study suggest the Deschutes River and small pipes as sources of bacteria. An additional source is Percival Creek and the aquatic bird populations of the lake. The Deschutes River accounts for 93 percent of the total coliform, 99.7 percent of the fecal coliform, and 98.7 percent of the fecal streptococci if only loadings by Percival Creek and the Deschutes River are considered. The Deschutes River annually contributed 3.4×10^9 , 1.4×10^9 , and 2.6×10^9 total coliform, fecal coliform, and fecal streptococci numbers, respectively.

These contributions could easily be maintained by the bird population on the river or in the lake, as calculated in table 3. A single bird could contribute 5.9×10^{10} total coliforms, 3.9×10^{10} fecal coliforms, and $.5 \times 10^{10}$ fecal streptococci per year. These estimates are the average of the ranges possible from the data collected in this study. For perspective, the figure for total coliforms is low relative to the contribution calculated by Gates (1959).

Given the tremendous potential for bacterial pollution by aquatic waterfowl, it might seem surprising that bacterial densities are not higher. Despite the high excretion of bacteria by waterfowl, not all the excreta enter the water directly (much is deposited onshore). Die-off rates could also help make observed concentrations lower than expected.

Bacterial densities were often highest in the Deschutes River and the south basin. No pipes are known to discharge into the south basin, which means the bacterial source is either upstream of station 47 or

consists of nonpoint sources, or both. One nonpoint source is birds, which could account for the increased fecal streptococci as water moved through the south basin.

Upstream in the river, levels of total coliforms were lower at Tumwater (river mile .4) on an average than those at station 47 (2,700 ± 2,000 for October 1976 to September 1977 at Tumwater). They were also lower at the STORET Olympia station (river mile 4.6) than at either Tumwater or station 47 (October 1976 to September 1977). An input between Tumwater and station 47 is indicated, but the time differences in the data limit the comparison's value.

Fecal coliforms are also higher at station 47 than at the Tumwater and Olympia STORET stations. Again, a fecal coliform source is indicated downstream of Tumwater but above station 47.

Pipes at stations 5 and 52 are the highest pipe sources of bacteria. These pipes often had high FC:FS ratios and can affect nearby lake quality.

In summary, it appears that contributions from the Deschutes River dominate the bacteriological quality of Capitol Lake. Most of this input appears to be nonhuman, but a low-level, possibly continual, human fecal source is indicated. These sources occur below station 47 from the many pipes entering the lake.

EFFECTS OF FISH FEEDING OPERATIONS ON PERCIVAL COVE

The contribution of fish food to Percival Cove was determined using feeding rates from August 1975 to June 1976 (Ref. 24) and using empirically determined nitrogen (N) and phosphorus (P) content of fish food obtained from DOE.* The fish food had a phosphorus content of 69.4 mg/gm (total P) and a nitrogen content of 14.9 mg/gm (total N) (see appendix B). The monthly contribution of this fish food to the N and P loading of Percival Cove is shown in table 4.

The nitrogen contribution from fish food reached a maximum of 48 percent in March and averaged only 2.8 percent. The phosphorus loading is more substantial, averaging 15 percent and reaching a peak of 90 percent in October. These nutrient contributions would have only small effects on the primary productivity because the contributions take place from September through April, which is a season of low algal growth.

The bacteriological quality of Percival Cove water is not directly affected by fish feeding activities because fish do not have an indicator bacterial flora as do humans (Ref. 25). Fish can resuspend bacteria by ingesting bacteria or sediment particles, but this is not an actual source of bacteria.

* On the basis of a conversation with Stephen Evans, Department of Fisheries Hatchery Manager, the August 1975 to June 1976 feeding schedule was judged similar to that of the 1976-77 period.

Table 4. COMPARISON OF FISH FOOD LOADINGS TO NATURAL LOADINGS OF NUTRIENTS IN PERCIVAL COVE

Month	Fish Feeding Operation			Natural Input		Percent Contribution by Fish Feeding	
	kg food	kg N	kg P	kg N	kg P	%N	%P
September	2.2	.033	.154	27,000	220	0	41
October	11,950	180	830	970	91	16	90
November	12,200	180	840	7,600	450	2.3	65
December	12,680	190	880	340	18,000	36	5
January	12,600	190	870	260	2,700	42	24
February	7,462	110	520	160	1,300	41	28
March	8,505	130	590	140	2,600	48	19
April	2,700	40	19	210	1,300	16	1
Total	68,100	1,020	4,500	36,700	26,700	2.8	14

The bacteriological quality of Percival Cove is closely related to the loadings by Percival creek, as indicated by figures 23, 24, and 25. This suggests that there are no pipes discharging to the cove. Given the generally close relationship between loading rates and cove densities, searching for other bacterial sources is unwarranted.

Algae and zooplankton in Percival Cove are similar to those in the rest of the lake. No statistical difference in total algal number, algal biovolume, or zooplankton density was found among any of the stations. In figure 26 these parameters are compared to the average of all stations. Overall, particularly for algae, the cycles in Percival Cove are similar to those in the rest of the lake.

Because of the low proportion of nutrient loading by fish feeding compared to the amount of natural loading, the lack of significant differences between biologic parameters in the cove compared to other stations, and the indirect effect of fish on indicator bacteria, the Percival Cove fisheries program is not seen to affect the lake in any significant manner. However, the process of "bumping" (draining and filling the lake with saltwater, partially to benefit the fisheries program) does affect water quality. These effects, which are positive in nature, are discussed in the next section.

NUTRIENTS IN CAPITOL LAKE

The nutrient levels determined in this study are similar to those found during the 1975 WSU study (Ref. 26), with only minor exceptions. Nutrients were considered in great detail in this study because of their effect on overall water quality and their central position in the scope of work.

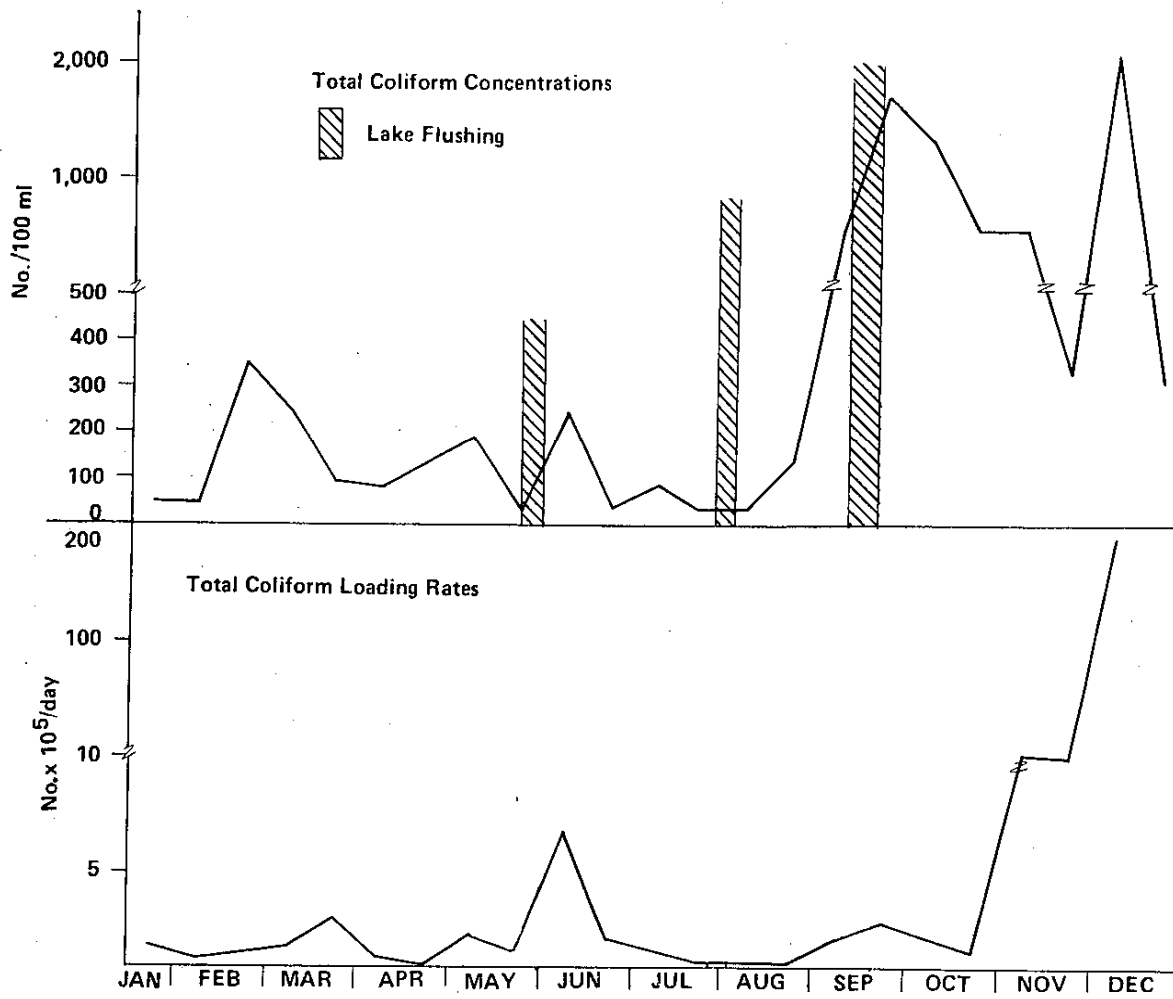

Figure 23

TOTAL COLIFORM LOADING RATES AND CONCENTRATIONS IN PERCIVAL COVE

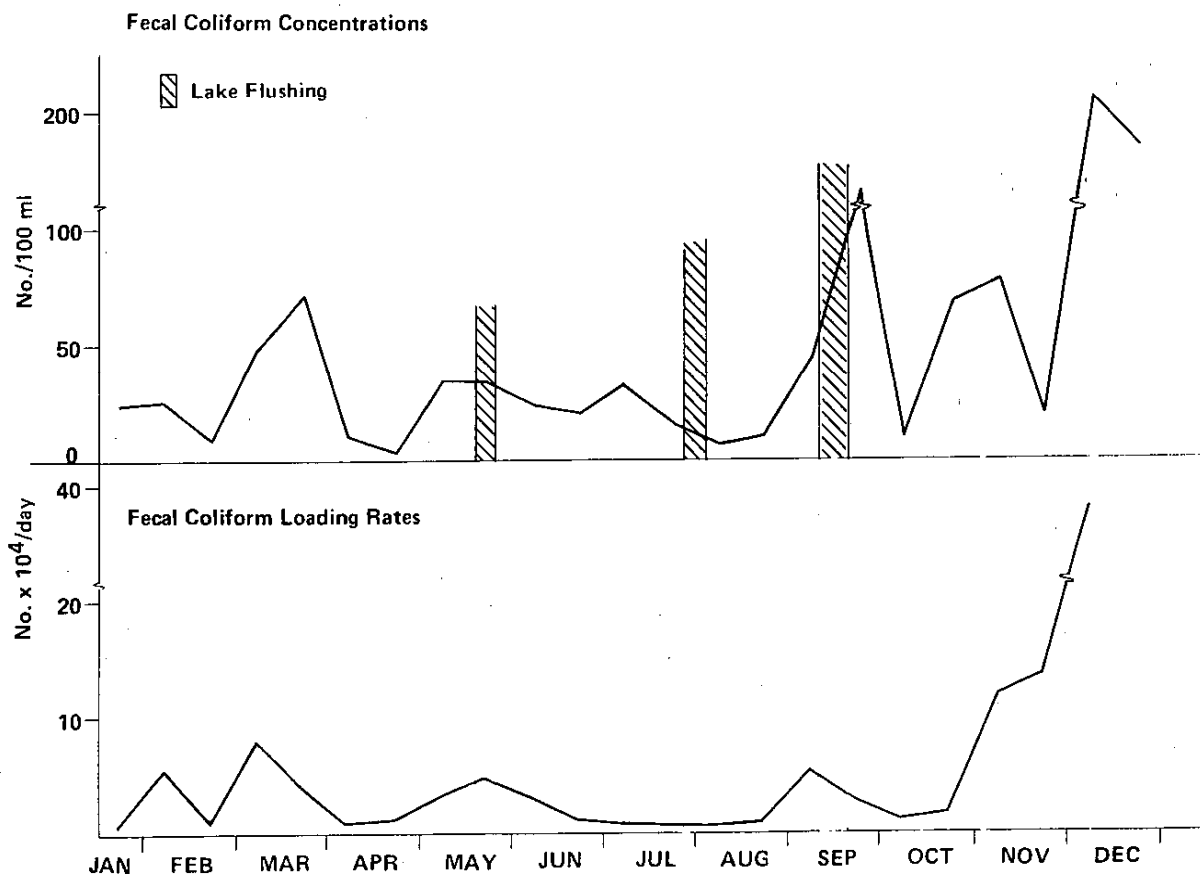

Figure 24

FECAL COLIFORM LOADING RATES AND CONCENTRATIONS IN PERCIVAL COVE

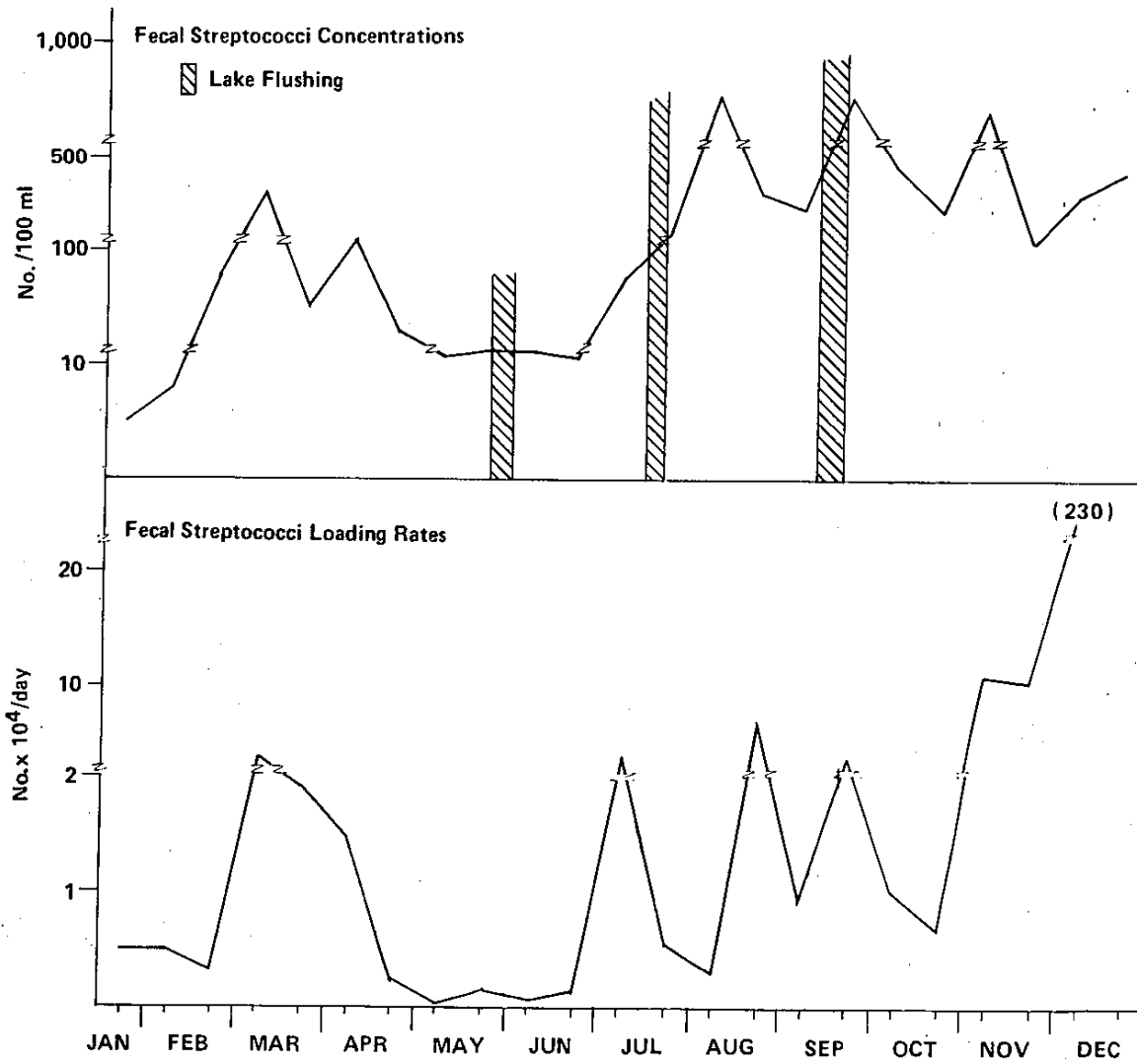

Figure 25

FECAL STREPTOCOCCI LOADING RATES AND CONCENTRATIONS IN PERCIVAL COVE

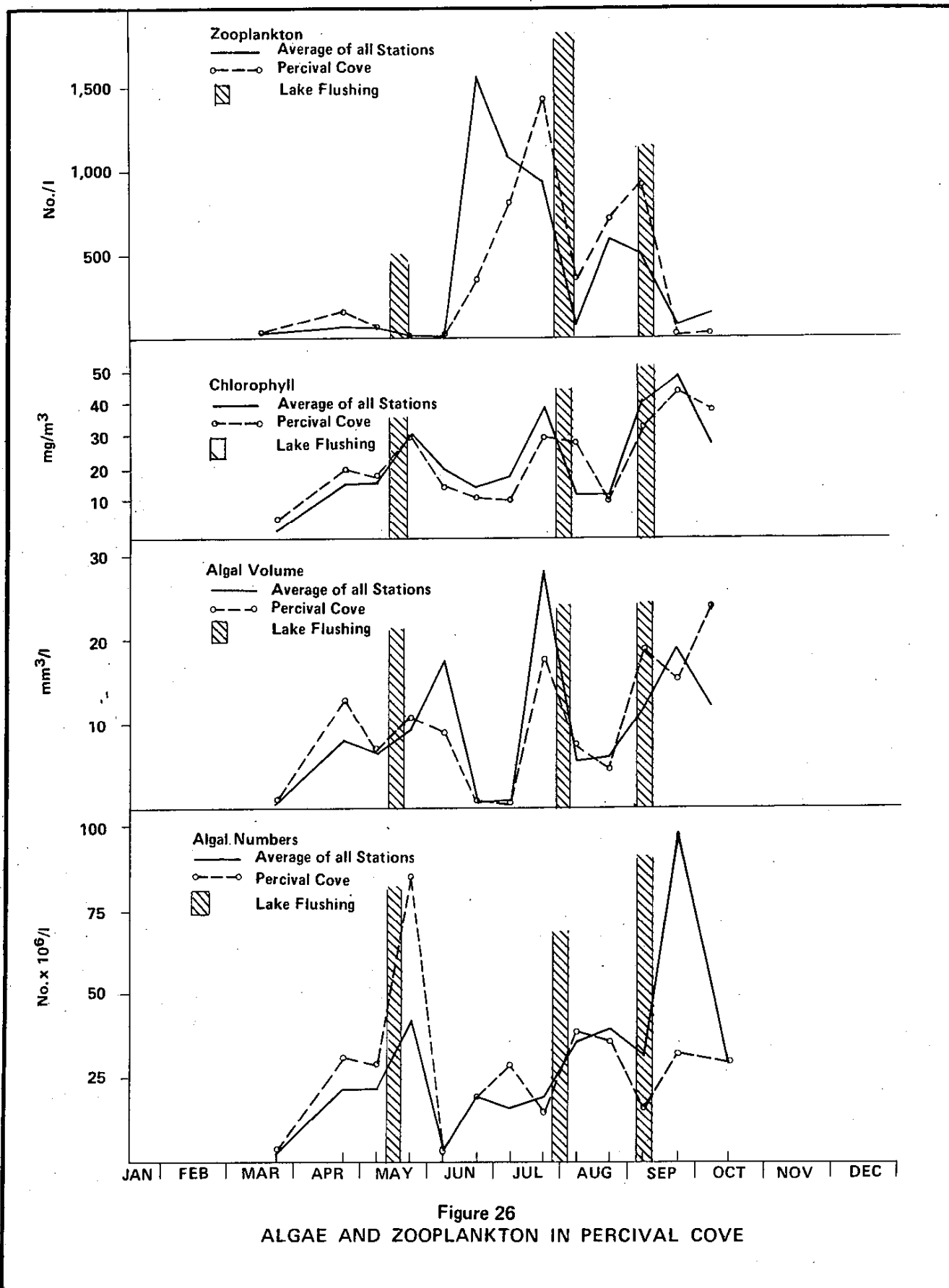

Figure 26
 ALGAE AND ZOOPLANKTON IN PERCIVAL COVE

Nutrient Dynamics and Sources

Nutrient loading in 1977 remained similar to that in 1973-74. Total nitrogen loading increased from 307.6 gm²/yr in 1974-75 to 406.7 gm²/yr in 1977. Total phosphorus loadings were 34.8 gm/m²/yr in 1974-75 and increased to 37.5 gm/m²/yr in 1977. Of the 1977 loadings, 84 percent of the phosphorus loading was ortho-phosphate and 57 percent of the nitrogen was inorganic nitrogen (ammonia and nitrate). The ortho-phosphate and inorganic forms are important because they account for the most readily available forms of both nutrients. Ready availability is important in a lake with low retention time, such as Capitol Lake.

Maximum ortho-phosphate loading occurred during November and December, with a peak also occurring in March (figure 27). The total phosphorus concentration increased with decreased flows during both this study and the WSU study. Ortho-phosphate concentrations were at detection limits much of the time, but a similar pattern of concentration decrease with decreased flow was found. An exception to this is the peak in ortho-phosphate during early March (figure 28).

The nitrogen concentration was inversely proportional to flow during the 1974 study. In the present study, nitrate was found more proportional to flow, although periods of inversity existed. Ammonia concentrations were often below detection, but apparently increased with flow (figure 28).

During the year, the Deschutes River accounted for 71 percent of the total phosphorus loading (considering the Deschutes, Percival Creek, and fish feeding as the only sources) and 79 percent of the total nitrogen input. For available forms, the comparison was 92 percent ortho-phosphate from the Deschutes (fish food not included) and 92 percent of the inorganic nitrogen (fish food not included). In 1974-75 the Deschutes provided 94 percent of the total phosphorus inflow and 88 percent of the total nitrogen (considering Percival Creek and the Deschutes River as the only sources).

These levels of nitrogen and phosphorus loadings are high. Vollenweider (Ref. 27) suggests 2.0 gm/m² total N and .30 gm/m²/yr total P as dangerous loading rates for lake eutrophication in lakes averaging 5 meters in depth. For both total and available N and P forms, Capitol Lake is far beyond these loading limits (figure 29). The rates at Capitol Lake are 37.5 gm/m²/yr total P, 19.4 gm/m²/yr ortho-phosphate, 406.7 gm/m²/yr total N, and 253.1 gm/m²/yr inorganic nitrogen. The loading of the Deschutes River alone places the lake beyond dangerous limits, and the loading of Percival Creek (10.8 gm/m²/yr total P and 84.4 gm/m²/yr total N) would still place the lake beyond tolerable loading rates. The same was true in 1974-1975. The fact that the loading is also extremely high in available nutrients precludes the chance of nutrient loss that would occur if the nutrients were in unavailable form.

Nitrate concentrations remained fairly constant from the Olympia STORET Station (river mile 4.6), to the Tumwater station (river mile .4), to

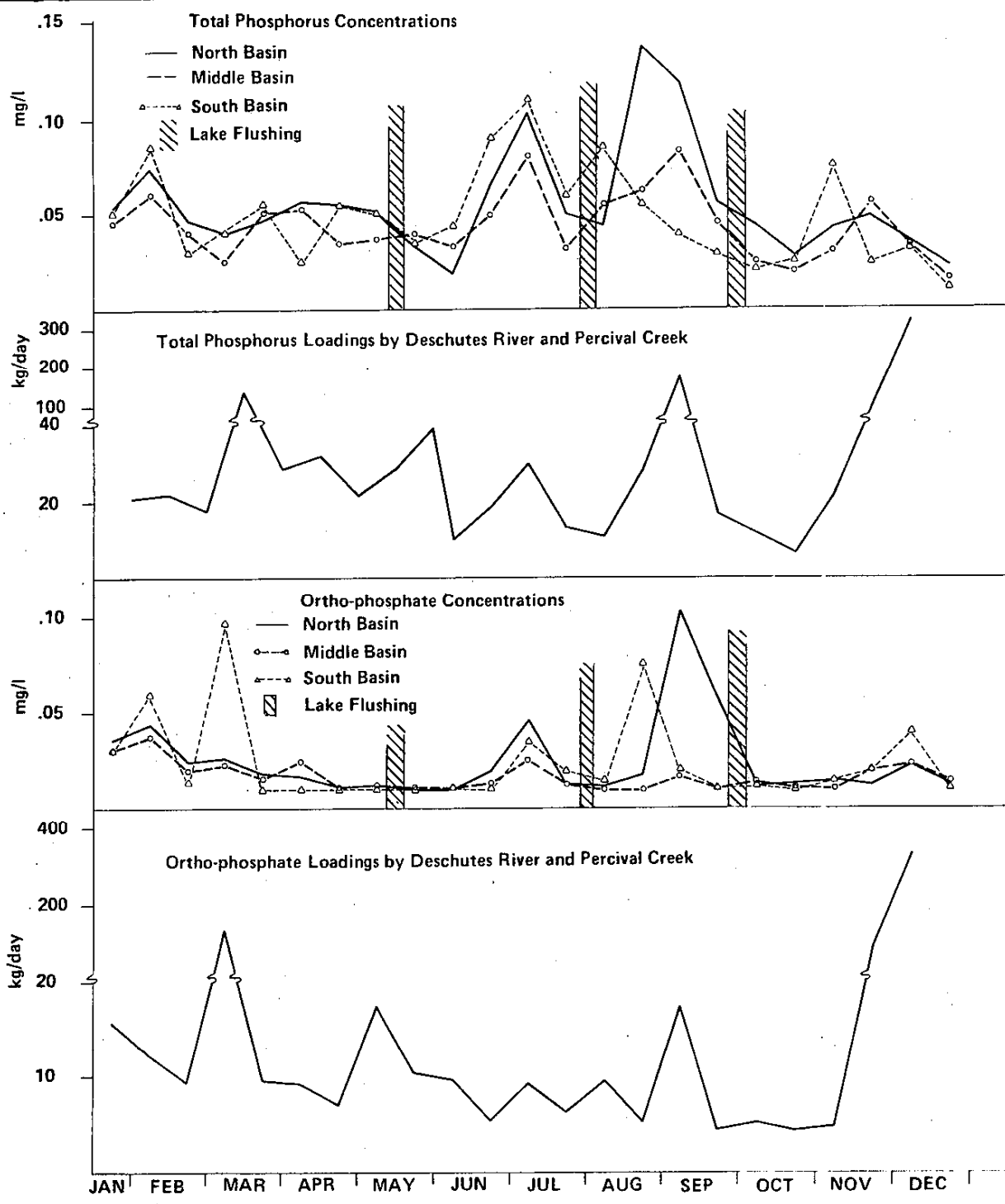

Figure 27
 TOTAL PHOSPHORUS AND ORTHO-PHOSPHATE LOADINGS AND CONCENTRATIONS BY BASIN

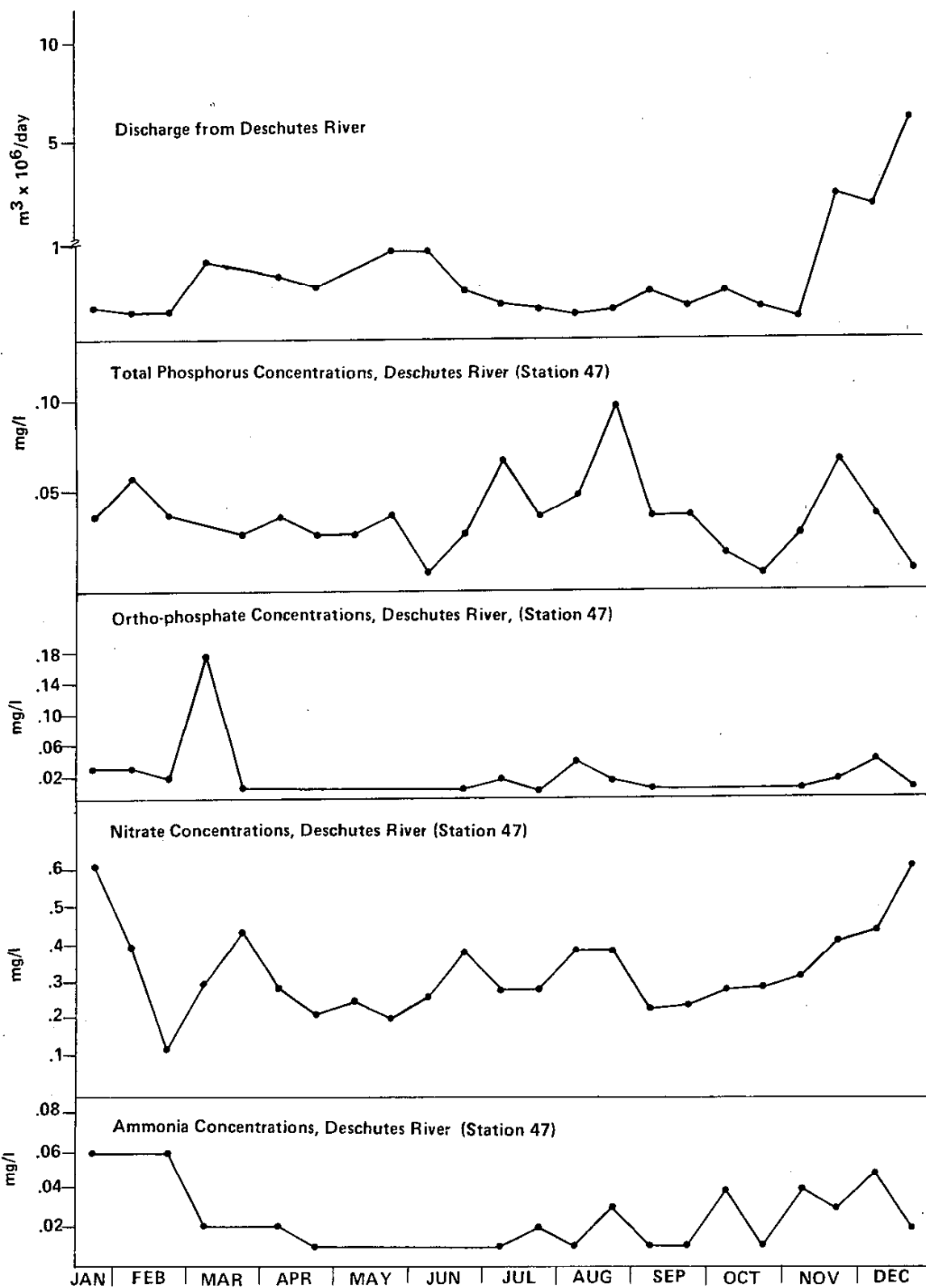

Figure 28
DISCHARGE AND NUTRIENT CONCENTRATIONS, DESCHUTES RIVER

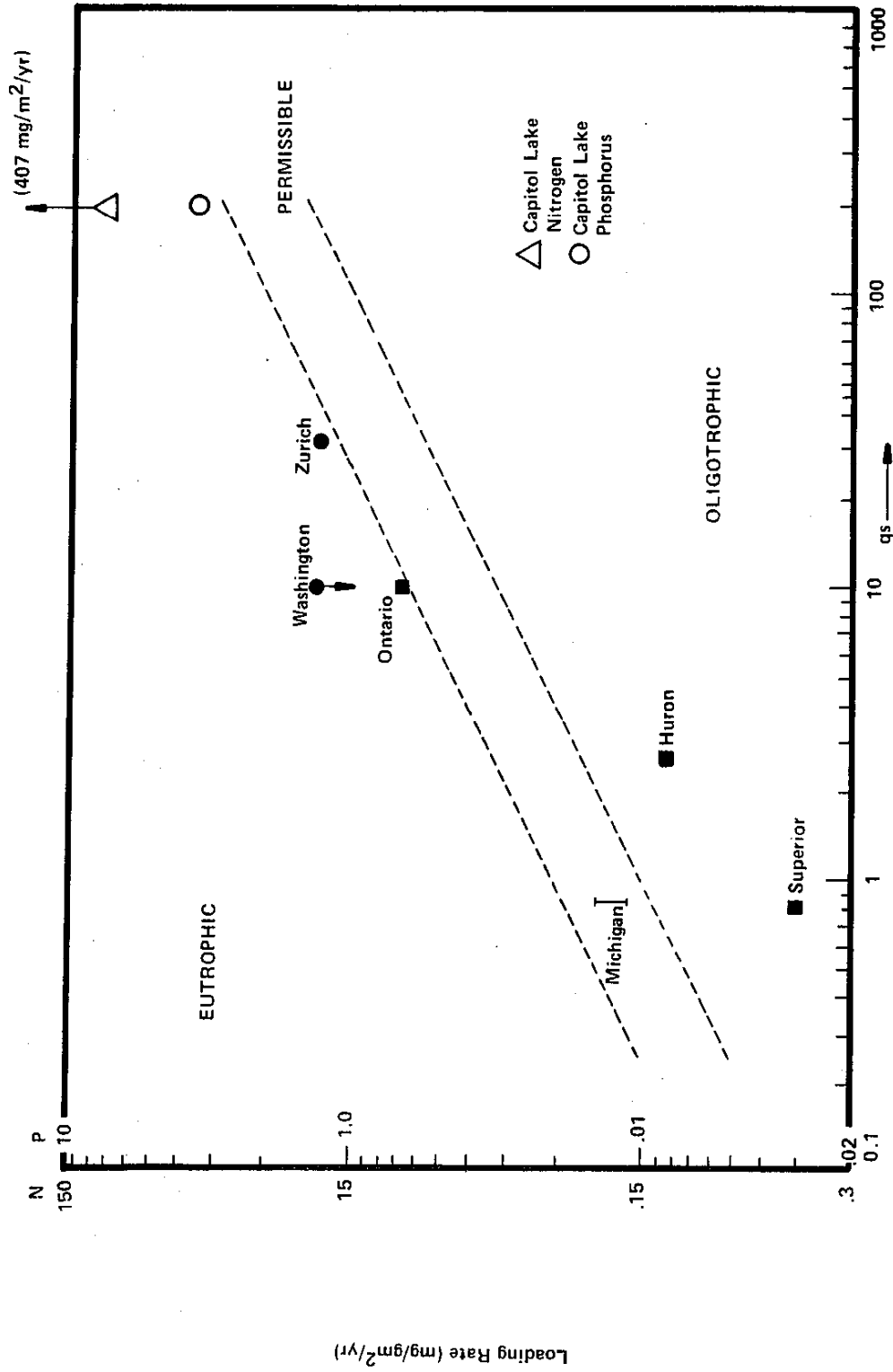

Figure 29

LAKE TROPHIC STATE ACCORDING TO VOLLENWEIDER MODEL

station 47. Ammonia levels increase at the middle station, but are lowest at station 47. Ortho-phosphate concentrations increase throughout this series of stations, while total phosphorus concentration is higher at the Tumwater station than at the stations above and below the Tumwater station. A nutrient source is indicated near the Tumwater STORET station for ammonia and total phosphorus, and a continual input of ortho-phosphate is implicated in the lower 4 miles of the river.

The data during this study point to the Deschutes River as the dominant source of nutrients to the lake, followed by Percival Creek for nitrogen, followed by either the creek or fish food for phosphorus. Analysis of variance of stations showed station 5 to have significantly more ammonia, stations 51 and 52 to have significantly more nitrate, 51 and 5 to have significantly more total phosphorus, and stations 5, 57, 51, 55, and 59 to have significantly higher ortho-phosphate concentrations. These inflow stations did not significantly increase any nearby lake station parameters except ortho-phosphate. Ortho-phosphate showed a localized effect at station 55, but the overall loading due to inflow from station 5, compared to the Deschutes River and Percival Creek, is negligible.

Average levels of nitrate, ammonia, ortho-phosphate, and total phosphorus for each station are shown in figures 30, 31, 32, and 33, respectively. Average levels of ammonia are higher in Percival Cove, probably because of fish excretions and fish food (Ref. 28). In the lake, ammonia levels are fairly uniform at .02 mg/l. Ammonia levels for each basin, however, do not closely follow loading rates (figure 34). This is due both to the rapid uptake of ammonia by algae and plants and to the production of ammonia within the lake and small local sources such as station 5. It also appears that flushing increases ammonia as seen by the positive correlation between conductivity (which increases during flushing) and ammonia (table 5).

On the average, nitrate concentrations decrease proceeding downstream through the lake (figure 30), showing the effects of the loading by the Deschutes River and of the decrease due to uptake. Stations of higher concentration occur from local sources. Figure 34 shows the relationship of nitrate loading to levels in the basins. Levels follow loadings quite clearly, and levels decrease as water moves through the basin. Maximal decreases occur during the summer growing season when uptake is high and retention is high. Flushing does not affect nitrate significantly, as seen by the low correlation (table 5).

Ortho-phosphate levels are, on the average, quite uniform at .02 mg/l across the lake (figure 32). Levels at station 6 are higher, possibly because of inflows from station 5. Station 23 is higher, possibly because of fish food. Ortho-phosphate levels follow loading rates fairly well in the south basin, and to a smaller extent in the other basins, until winter (figure 27). During winter, loading increases because of increased discharge, but concentrations are approximately the same in the lake because of an equal increased discharge from the lake.

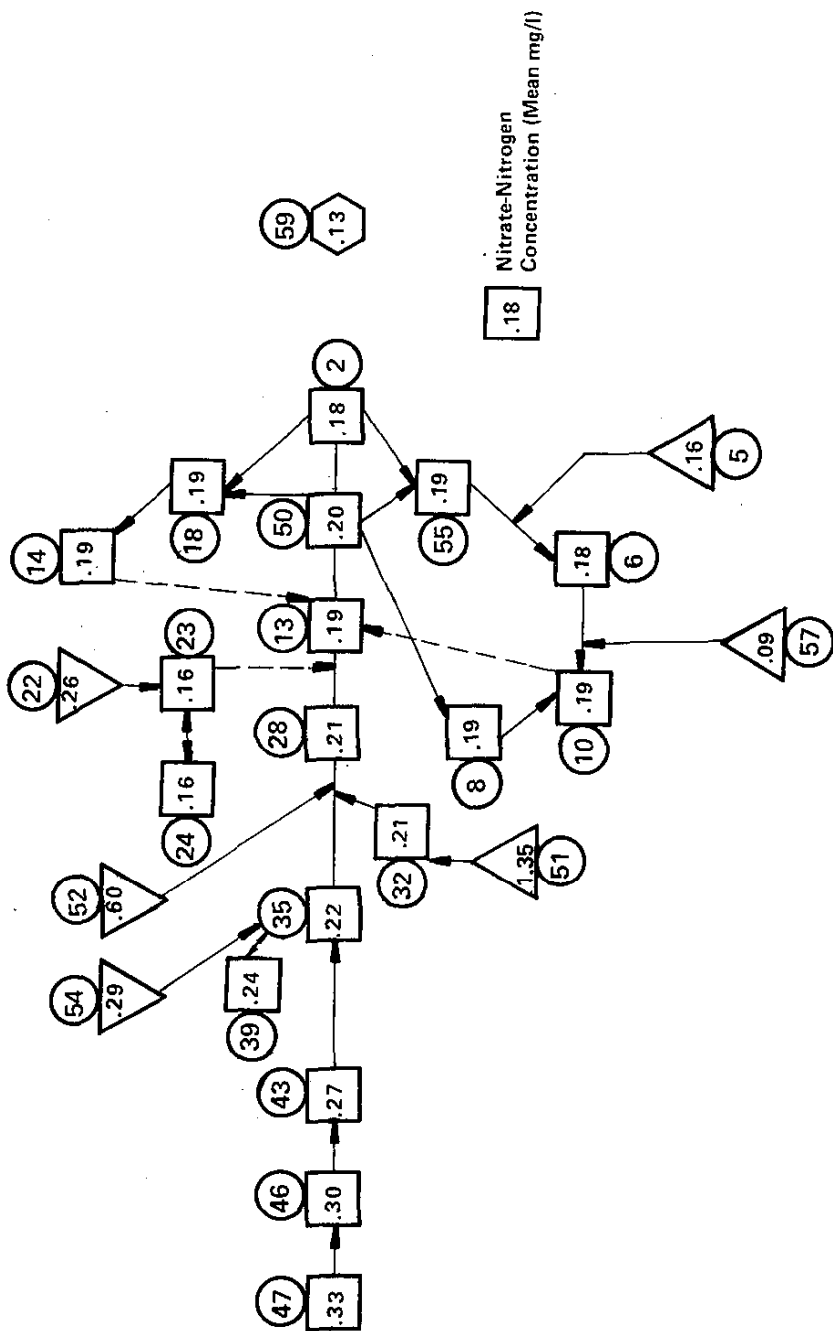

Figure 30
 DISTRIBUTION OF MEAN NITRATE-NITROGEN CONCENTRATIONS
 BY STATION

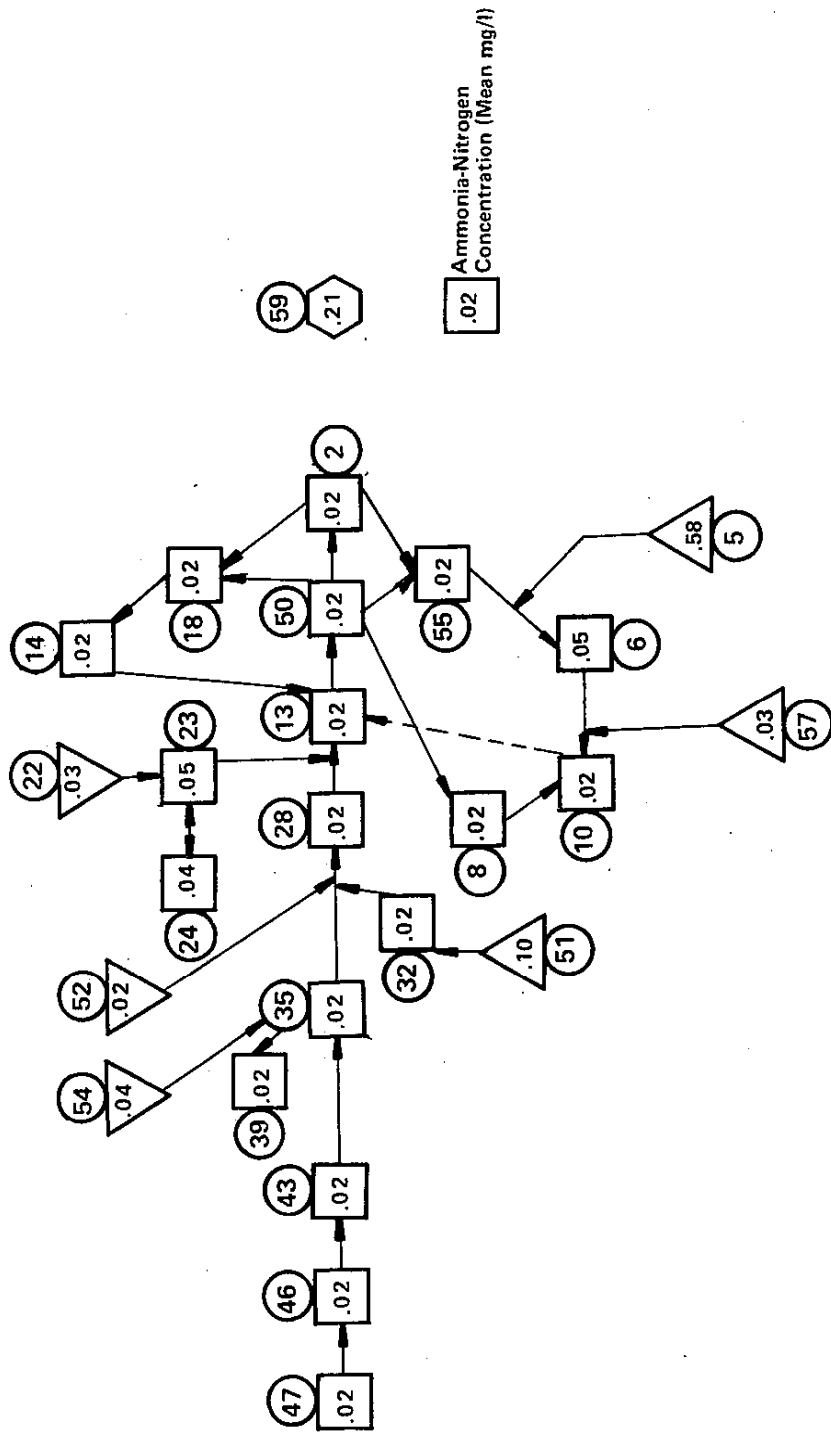

Figure 31
 DISTRIBUTION OF MEAN AMMONIA-NITROGEN CONCENTRATIONS
 BY STATION

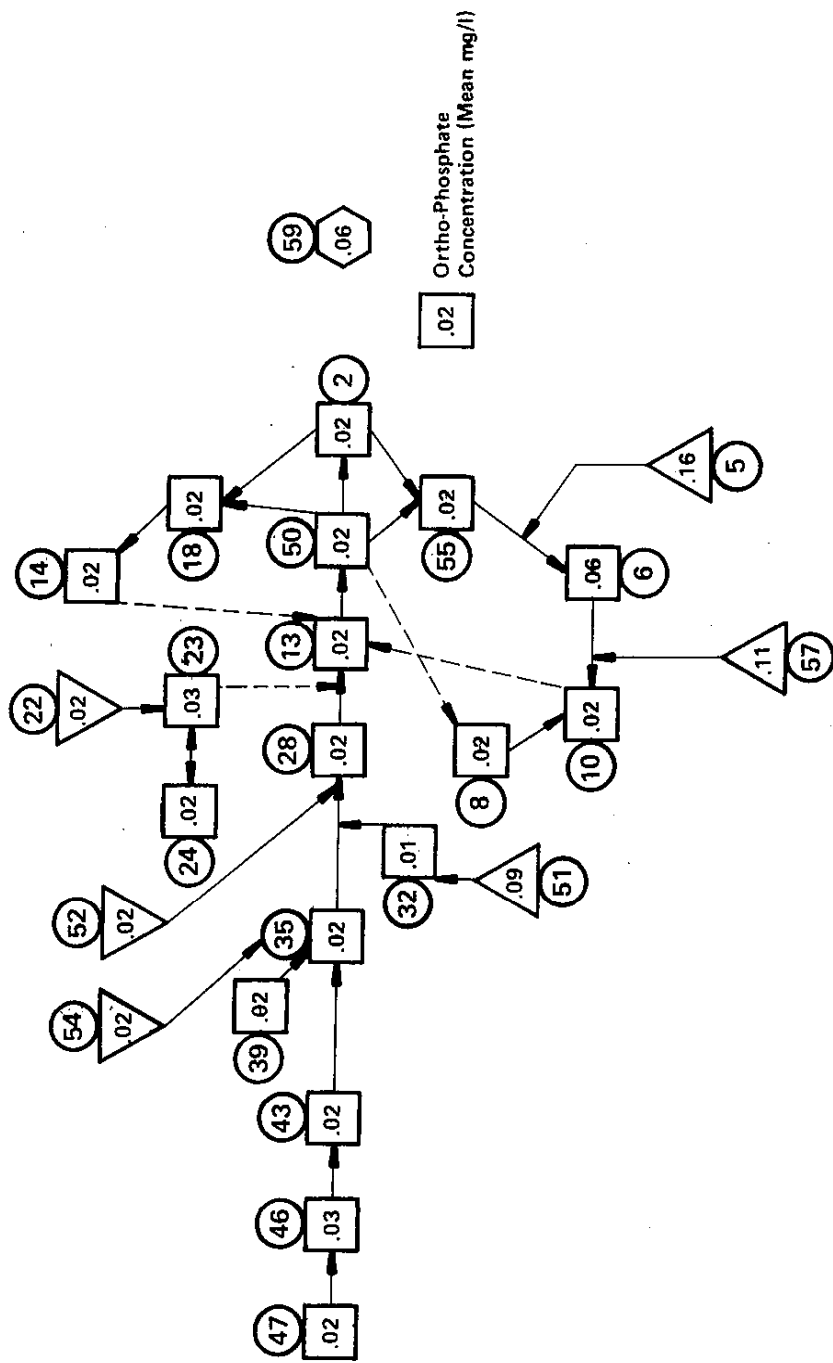

Figure 32
 DISTRIBUTION OF MEAN ORTHO-PHOSPHATE CONCENTRATIONS
 BY STATION

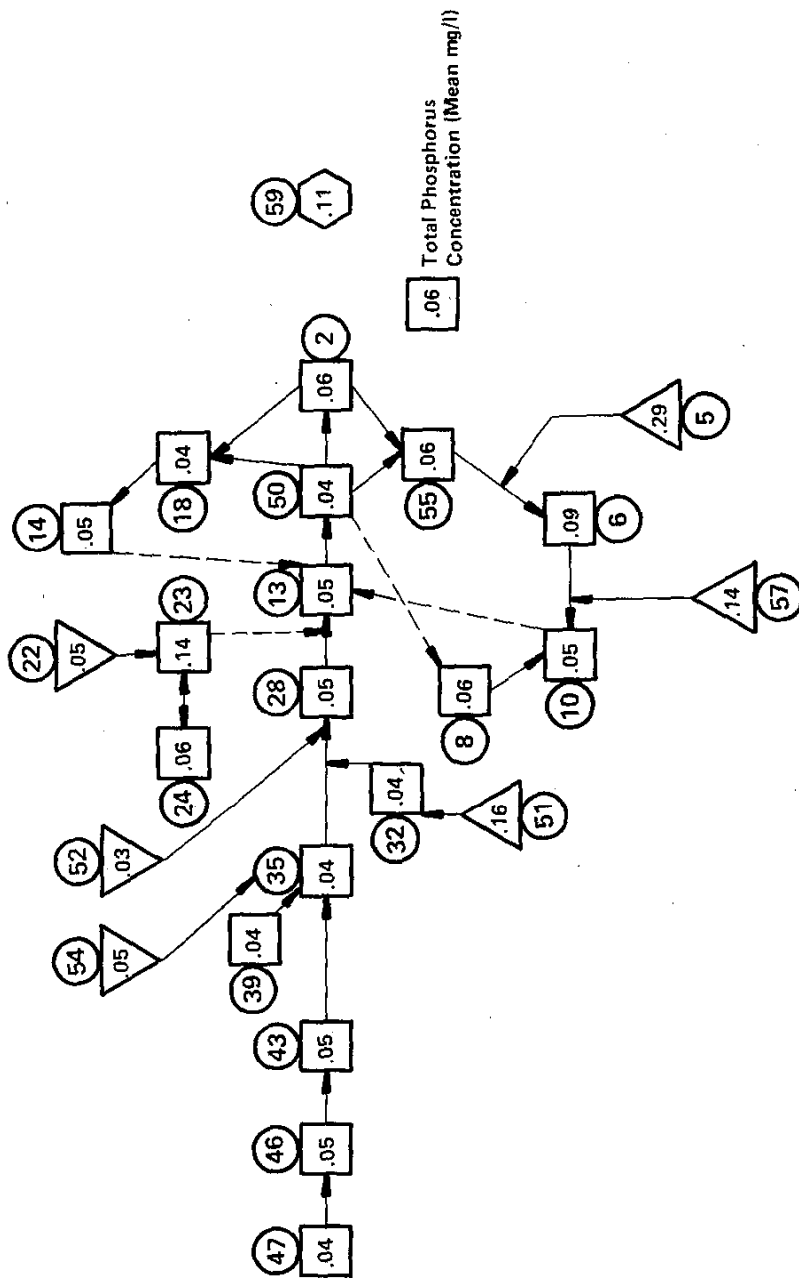

Figure 33
 DISTRIBUTION OF MEAN TOTAL PHOSPHORUS CONCENTRATIONS
 BY STATION

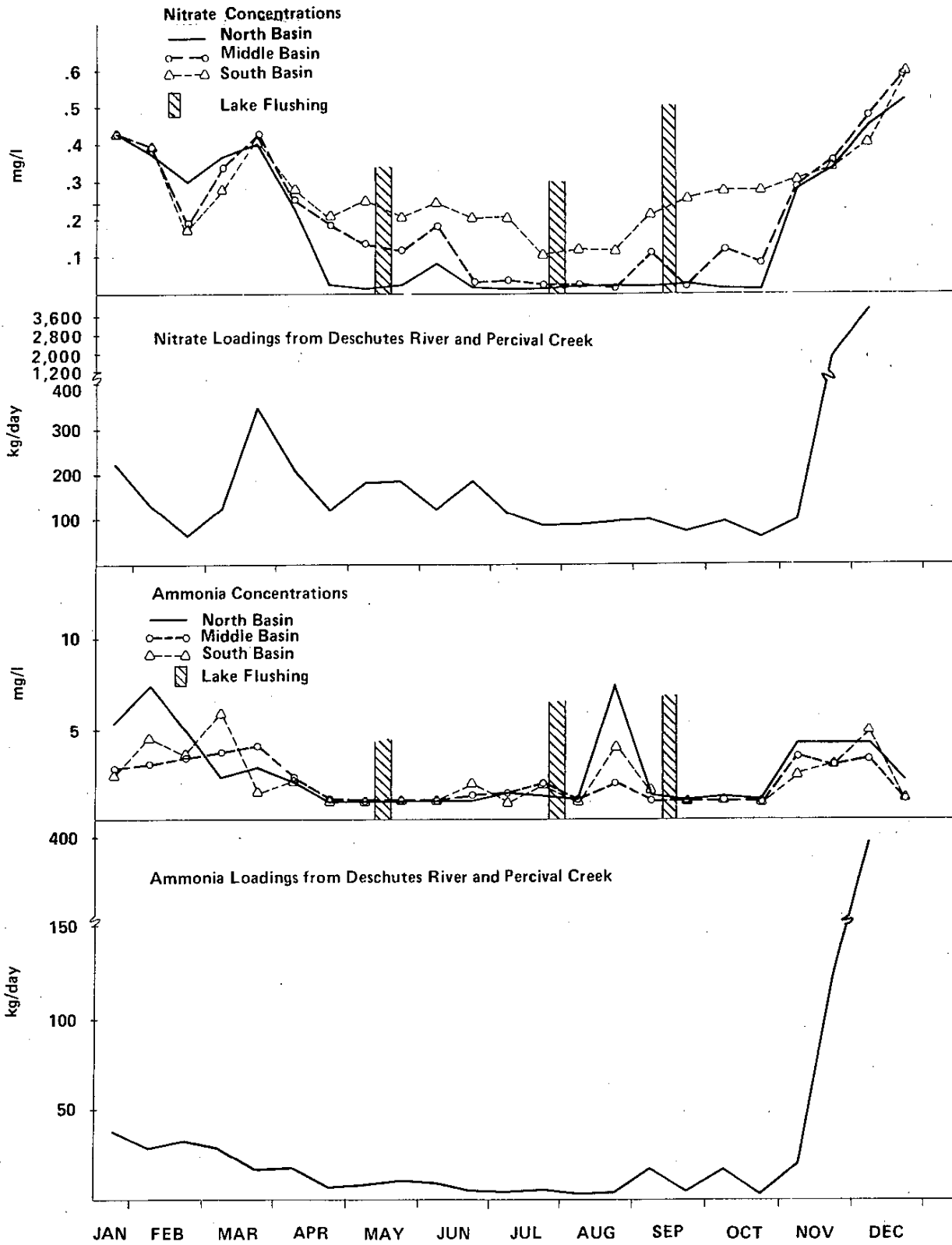

Figure 34
 NITRATE AND AMMONIA LOADINGS AND CONCENTRATIONS BY BASIN

Table 5. CORRELATION OF SPECIFIC CONDUCTANCE TO INDICATOR BACTERIA, NUTRIENTS, AND WATER CLARITY DURING THE SUMMER

	Specific Conductance (corrected, $\mu\text{mhos}/\text{cm}^2$)
Total Coliforms (no./100 ml)	-.07
Fecal Coliforms (no./100 ml)	-.05
Fecal Streptococci (no./100 ml)	-.06
Total Phosphorus (mg/l)	-.03
Ortho-phosphate (mg/l)	-.01
Nitrate-Nitrogen (mg/l)	-.12
Ammonia-Nitrogen (mg/l)	.25*
Secchi Depth (m)	.39*

* Significant at $P=.05$.

Total phosphorus shows a more heterogeneous pattern across the lake, both with concentrations varying between .04 and .06 mg/l (figure 33). Lake levels follow input rates to some extent until winter, when increased flow rates actually result in a decrease in lake concentration (figure 27 and table 6). This is because the concentration in the river does not increase in proportion to discharge (figure 28), and river concentrations actually decrease as maximum flows are encountered. Concentrations of total phosphorus show no significant relation to summer conductivities, indicating no measurable effect of flushing on phosphorus. This is surprising because Budd Inlet levels are generally twice the lake concentrations.

Table 6. CORRELATIONS OF SELECTED WATER QUALITY PARAMETERS TO DISCHARGE, RAINFALL, AND WATER TEMPERATURE

	Discharge, Deschutes River (m ³ /day)	Discharge, Percival Creek (m ³ /day)	Rainfall (inches/ day)	Water Temperature (°C)
Total Phosphorus (mg/l)	-.12*	-.16*	-.01	.06
Ortho-phosphorus (mg/l)	-.02	-.03	.02	-.00
Nitrate-Nitrogen (mg/l)	.48*	.61*	.10*	-.20*
Ammonia-Nitrogen (mg/l)	.13*	.16*	.06	-.04
Kjeldahl Nitrogen (mg/l)	.18*	.16*	-.00	-.00
Secchi Depth (m)	-.58	-.63	-.14	-.03
Suspended Solids (mg/l)	.40*	.39*	-.15*	-.02

* Significant at P=.05.

Kjeldahl nitrogen levels are shown in figure 35. Station averages are heterogeneous, with peak concentrations at stations 23 and 55. There is also a slight increase as water flows through the lake. This increase represents the conversion of nitrate and ammonia to organic forms that are measured by the Kjeldahl analysis. There is no strong relationship between Kjeldahl nitrogen and algal volumes and numbers. The amounts of Kjeldahl nitrogen are positively correlated to discharge of both Percival Creek and the Deschutes River, indicating that input levels are key determinants in lake concentrations.

Nutrient Balances and Limiting Factors

Relative loadings and ambient concentrations of nitrogen and phosphorus are important for determining whether nutrients are limiting. Loading rates and sources are shown in figure 36. Inorganic nitrogen and ortho-phosphate have been placed on equivalent scales in this figure by multiplying ortho-phosphate concentrations by 10.6 (using balanced ratios from Chiaudini and Vighi and Greene *et al.*--Ref. 29, 30). Through

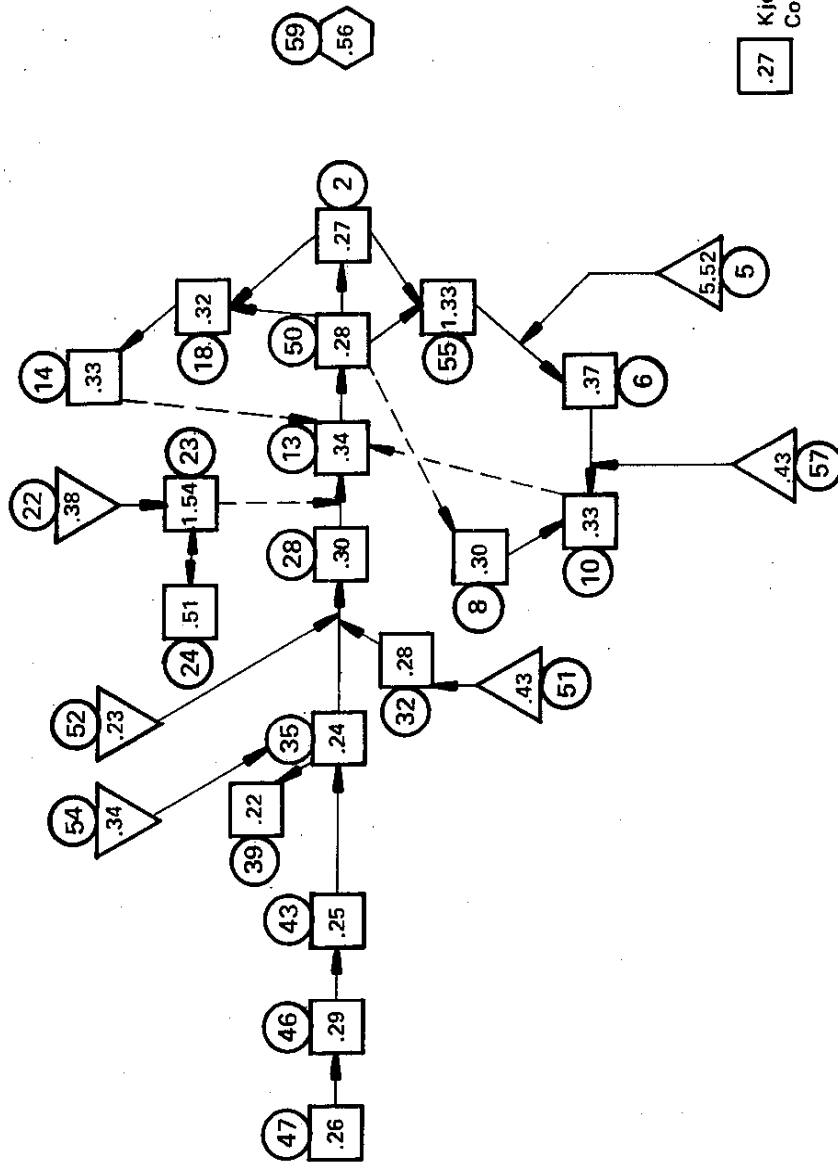

Figure 35
DISTRIBUTION OF MEAN KJELDAHL NITROGEN CONCENTRATIONS
BY STATION

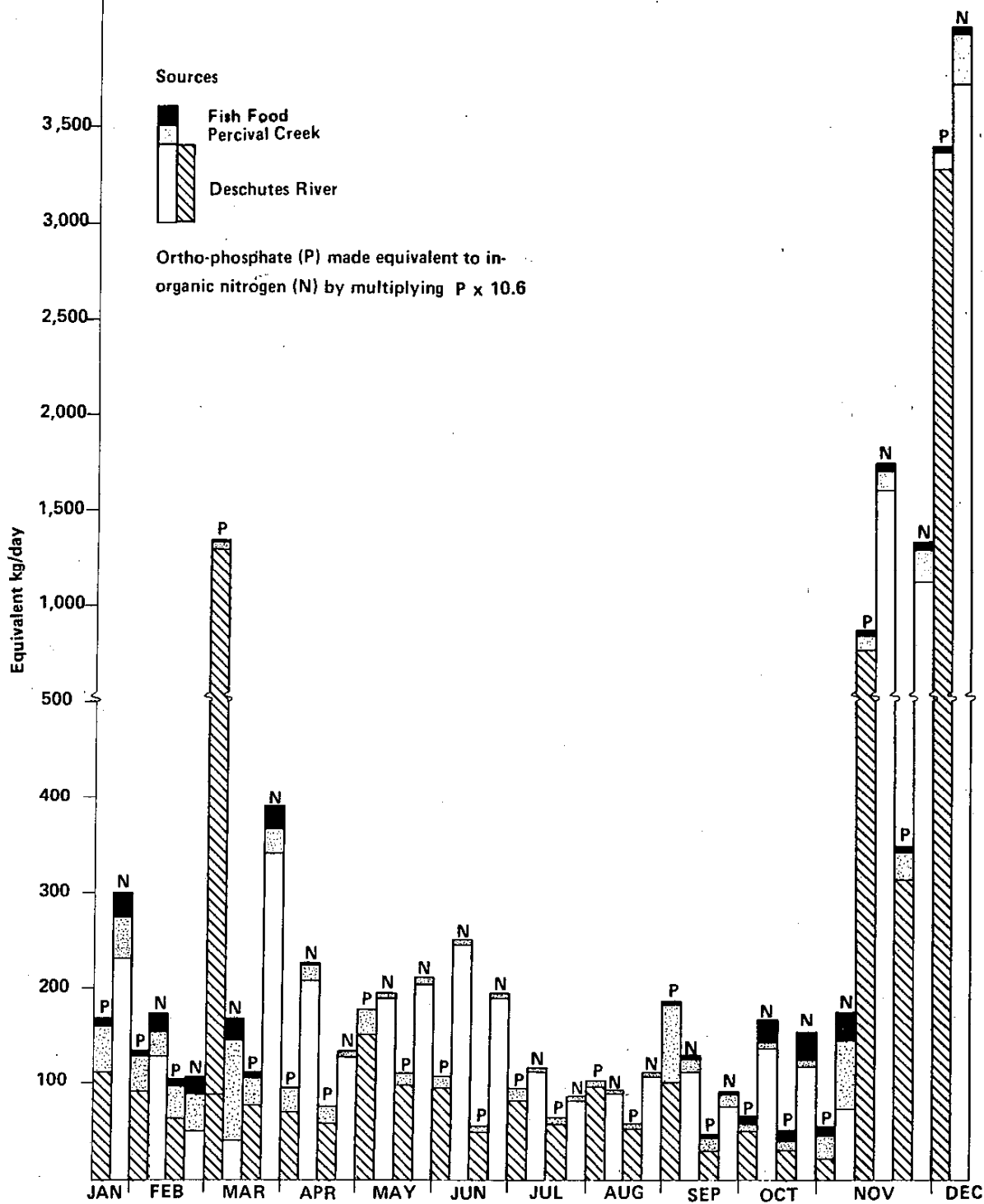

Figure 36
 RELATIVE LOADINGS AND SOURCES OF ORTHO-PHOSPHATE
 AND INORGANIC NITROGEN

most of the year, the available nitrogen loading exceeds ortho-phosphate loading, making phosphorus loading appear limiting. During the middle of the growing season, however, loading rates become very similar, and occasionally phosphorus loading exceeds nitrogen loading. This would make nitrogen limiting.

Figure 37 shows the ambient concentrations of available nitrogen and phosphorus in terms of the ratio of inorganic nitrogen to ortho-phosphate. The same pattern of a shift from initial phosphorus limitation to later nitrogen limitation is indicated by this graph. The shift occurs in late June for the north and middle basins and in July for the south basin. The south basin also returns to phosphorus limitation earlier than the other basins, which reflects its smaller size and dependence upon riverine conditions.

The WSU report (Ref. 31) considered nitrogen as limiting because of the drop of available nitrogen to below detectable levels while phosphorus remained above detectable limits. During 1977, the situation appeared more complex, with a shift in limiting nutrients from one part of the growing season to the next. This indicates that both nitrogen and phosphorus inputs must now be curtailed to reduce algal growth. Because no point source of these nutrients is implicated, curtailing inputs will be very difficult.

ALGAE AND ZOOPLANKTON

Algae identified in Capitol Lake are listed in table 7. Dominant genera were *Anabaena*, *Cyclotella*, and *Stichococcus*. Diatoms were dominant through most of the period from March through October, but green algae and blue-green algae occasionally dominated the biovolume of algae (table 8). In the WSU study, diatoms were found to be the dominant algal type during most of the growing season studied, with green algae becoming important during July and August. *Volvox*, *Gloetrichia*, and windrows of *Oscillatoria* were reported. The occurrence of *Aphanizomenon* was also noted, although not in "nuisance proportions."

Algal numbers and biovolume were significantly correlated to chlorophyll but not to each other (table 9), and biovolume and chlorophyll followed each other through the growing season to a much greater extent than algal numbers (figure 38). Chlorophyll and volumes are the most appropriate parameters to follow because they reflect the aesthetic appearance of the water to a greater extent than does number.

Three peaks in chlorophyll and biovolume occurred, each followed by "crashes" after flushing (figure 38). Algal numbers also followed this pattern. Each station in the lake followed similar patterns as well (figure 39).

The first bloom occurred in April and May and was dominated by *Stichococcus*. The second bloom was larger and was dominated by *Anabaena*. This bloom occurred during June and July. During August, another bloom, dominated by *Cyclotella*, occurred. A final bloom, not followed to completion, was occurring in October and was dominated by *Stichococcus*.

Table 7. ALGAE IDENTIFIED IN CAPITOL LAKE, 1977

<i>Bacillariophyceae</i> (diatoms)	<i>Chlorophyceae</i> (green algae)
<i>Amphoroa</i> spp.	<i>Chlamydomonas</i> spp.
<i>Ankistrodesmus falcatus</i>	<i>Chlorella vulgaris</i>
<i>Asterionella</i> spp.	<i>Dictyosphaerium ehrenbergianum</i>
<i>Asterionella formosa</i>	<i>Dysmorphococcus variabilis</i>
<i>Cyclotella</i> spp.	<i>Eudorina elegans</i>
<i>Diploneis</i> spp.	<i>Golenicinia radiata</i>
<i>Fragilaria crotonensis</i>	<i>Micratinium pusillum</i>
<i>Melosira granulata</i>	<i>Mougetia</i> spp.
<i>Melosira herzogii</i>	<i>Oocystis</i> spp.
<i>Melosira islandia</i>	<i>Pandorina morum</i>
<i>Meridion circulare</i>	<i>Pediastrum boryanum</i>
<i>Navicula</i> spp.	<i>Scenedesmus bijuga</i>
<i>Nitzschia</i> spp.	<i>Scenedesmus quadrata</i>
<i>Stephanodiscus niagarae</i>	<i>Schroderia setigera</i>
<i>Synedra</i>	<i>Spraerocystis schroeteri</i>
	<i>Staurastrum paradoxum</i>
	<i>Stichococcus scupulines</i>
	<i>Trebouxia</i> spp.
<i>Cyanophyceae</i> (blue-green algae)	<i>Chrysophyceae</i> (yellow-green algae)
<i>Anabaena</i> spp.	<i>Chaetoceros</i> spp.
<i>Anabaena circinalis</i>	<i>Dinobryon</i> spp.
<i>Anabaena flos-aquae</i>	<i>Dinobryon calciiformis</i>
<i>Anabaena planctonica</i>	<i>Dinobryon sertularia</i>
<i>Anabaena spiroides</i>	<i>Dinobryon sociale</i>
<i>Coelosphaerium naegelianum</i>	<i>Mallomonas</i> spp.
<i>Oscillatoria lemnetica</i>	<i>Mallomonas acaroides</i>
<i>Oscillatoria tenuis</i>	
<i>Cryptophyceae</i> (Cryptomonads)	<i>Euglenophyceae</i> (Euglenoids)
<i>Cryptomonas</i> spp.	<i>Cryptoglana pigra</i>
<i>Rhodomonas</i> spp.	<i>Cryptoglana niaga</i>
<i>Dinophyceae</i> (Dinoflagellates)	
<i>Dinoflagellates</i> , unidentified	
<i>Ceratium mirundinella</i>	

Each bloom was apparently ended by flushing (figure 39), and flushing appears to severely limit *Anabaena* but not *Stichococcus* or *Cyclotella*. The latter two algae are more desirable than *Anabaena*.

Correlations of chlorophyll, biovolumes, and algal numbers to various possible determinant factors (table 9) show negative correlations to most nutrients. This merely indicates a decrease in nutrients as algal biomass increases. For ortho-phosphate, nitrate, and ammonia, this is due to both uptake and low input rates. For total phosphorus and

Table 8. CAPITOL LAKE ALGAL VOLUMES

TAXA		Algal Volumes By Family (mm ³ /liter)																							
		22 March			19 April			10 May			24 May			25 July			6 July			20 September			12 October		
		50	28	24	50	28	24	50	55	28	50	24	24	50	55	28	50	24	24	50	55	28	50	24	24
Station	50	28	24	50	28	24	50	55	28	50	24	24	50	55	28	50	24	24	50	55	28	50	24	24	
Bacillariophyceae	.136	.960	2.15	2.28	3.35	6.00	.26	5.30	.47	1.81	.47	1.63	1.34	1.36	.48	.79									
Chlorophyceae	.019	.012	--	.10	4.02	4.22	.27	6.87	4.86	3.82	1.99	4.06	10.82	5.88	2.87	10.16									
Cryptophyceae	.004	.075	--	.12	.02	.09	--	.38	.41	.20	.36	.38	1.30	1.83	.04	--									
Dinophyceae	--	.084	--	--	--	--	--	--	.02	--	--	--	--	--	--	--									
Cyanophyceae	.032	--	--	.25	--	--	--	--	--	--	--	.08	--	--	--	--									
Euglenophyceae	--	--	--	--	.27	--	--	--	.83	.27	.22	--	--	--	--	--									
Chrysophyceae	--	--	--	--	--	.11	--	.43	.07	--	--	--	--	--	--	--									
Microplankton ^a	.054	.067	.01	.07	.14	.13	.04	.14	.22	4.17	.06	.07	.04	.04	.03	.10									
TOTAL	.245	1.198	2.16	2.82	7.80	10.55	.58	13.13	6.88	10.28	3.09	6.22	13.50	9.11	3.42	11.05									
Station	50	28	24	50	28	24	50	28	24	50	28	24	50	28	24	50	28	24	50	28	24	50	28	24	
Bacillariophyceae	.94	1.21	.18	.06	1.58	.43	ND ^b	1.67	.18	.06	.62	.58	4.57	5.38	.82	9.36									
Chlorophyceae	6.63	3.97	.62	2.47	.99	.46	ND	1.82	.20	.04	.03	--	.02	--	.203	2.19									
Cryptophyceae	.18	.04	.02	.09	.14	.08	ND	.23	.13	.02	.19	.13	.18	.01	.09	.03									
Dinophyceae	--	--	--	--	--	--	ND	--	--	--	--	--	--	--	--	--									
Cyanophyceae	.12	.26	--	1.60	.26	.55	ND	1.90	4.72	6.92	1.43	1.10	54.72	21.77	7.13	6.25									
Euglenophyceae	--	--	--	--	--	--	ND	--	--	--	--	--	--	--	--	--									
Chrysophyceae	--	.09	--	.01	--	--	ND	--	--	.09	--	--	--	--	--	--									
Microplankton ^a	.11	.06	.05	.05	.21	.08	ND	.18	.78	.31	.59	.27	.15	.04	.15	.07									
TOTAL	7.99	5.63	.87	4.29	3.16	1.59	ND	5.79	6.00	7.34	2.96	2.08	59.63	27.2	8.40	17.90									
Station	50	28	24	50	28	24	50	28	24	50	28	24	50	28	24	50	28	24	50	28	24	50	28	24	
Bacillariophyceae	4.80	3.80	3.82	5.22	3.26	4.85	4.60	3.76	2.85	4.13	5.45	.10	18.99	14.88	6.80	.68	.42	.61	1.80	.65					
Chlorophyceae	.08	.17	.61	.46	.14	.23	1.61	.37	1.47	2.40	3.36	1.00	2.20	4.78	3.03	4.13	6.79	5.39	5.29	12.61					
Cryptophyceae	--	--	--	--	.20	.30	.10	--	.26	.13	.10	.11	--	--	--	--	.03	.13	.20	.10					
Dinophyceae	.26	.65	--	--	.23	--	--	--	.23	1.25	--	.14	.49	.16	--	--	--	--	--	--					
Cyanophyceae	--	--	--	1.8	.78	1.39	1.67	.31	.14	4.54	--	18.66	.28	4.90	.29	10.39	--	4.32	--	10.78					
Euglenophyceae	--	--	--	--	--	--	--	--	.03	--	--	--	--	--	--	--	.05	--	--	--					
Chrysophyceae	.19	--	--	--	--	.02	.09	--	--	--	--	.38	--	--	--	--	.04	.39	--	--					
Microplankton ^a	.15	.66	.20	.06	.02	.02	--	.08	.10	.38	.43	.40	.04	.06	.05	.16	.15	.09	.05	.12					
TOTAL	5.52	5.29	4.63	7.57	4.63	6.82	8.06	4.51	5.05	12.84	9.33	20.80	22.00	28.51	10.18	15.36	7.50	10.94	7.34	24.24					

^a Microplankton includes other unknown types.

^b No data.

Table 9. CORRELATIONS OF BIOLOGICAL CHARACTERISTICS TO PHYSICAL AND BIOLOGICAL PARAMETERS

	Algal Numbers (no./l)	Algal Volume (mm ³ /l)	Chlorophyll a (mg/l)	Zooplankton (no./l)
Total Phosphorus (mg/l)	.001	-.15	-.26	-.11
Ortho-phosphate (mg/l)	-.09	-.11	-.22	.11
Nitrate-Nitrogen (mg/l)	-.31	-.24	-.36*	.32*
Ammonia-Nitrogen (mg/l)	.03	-0.2	-.14	-.12
Kjeldahl Nitrogen (mg/l)	-.08	-.10	.02	-.12
Total Inflow (m ³ /day)	-.20	.04	.15	-.14
Ortho-phosphate Loading (kg/day)	-.15	-.15	-.25	-.12
Inorganic Nitrogen Loading (kg/l) (kg/day)	-.16	-.16	-.20	-.11
Algal Numbers (no./l)	1.00	.15	.48*	-.08
Algal Volume (no./l)		1.00	.48*	.13
Chlorophyll-a (mg/m ³)			1.00	.03
Zooplankton (no./l)				1.00

* Statistically significant at P=.05.

N = 36 for algal volume, algal numbers, chlorophyll, and zooplankton versus ortho-phosphate and inorganic nitrogen loading. N = 52 for others.

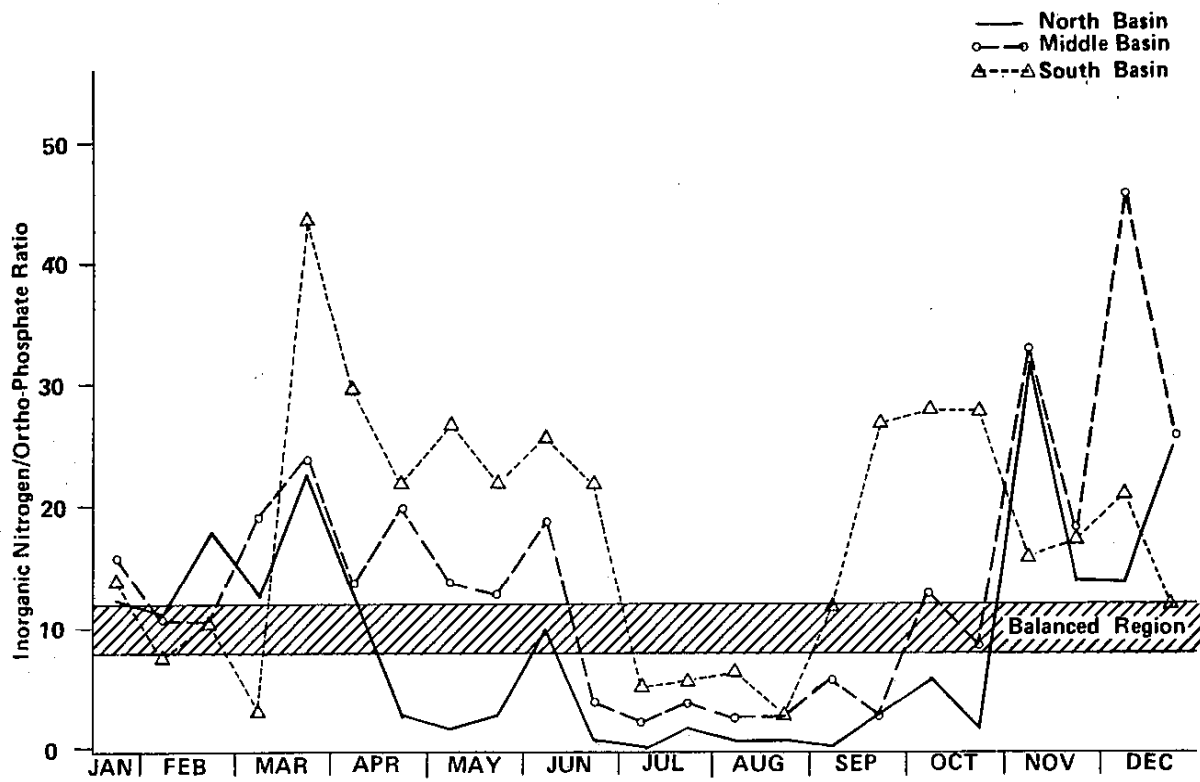

Figure 37
 RATIO OF AVAILABLE NITROGEN TO PHOSPHORUS
 AS AN INDICATION OF LIMITING FACTOR

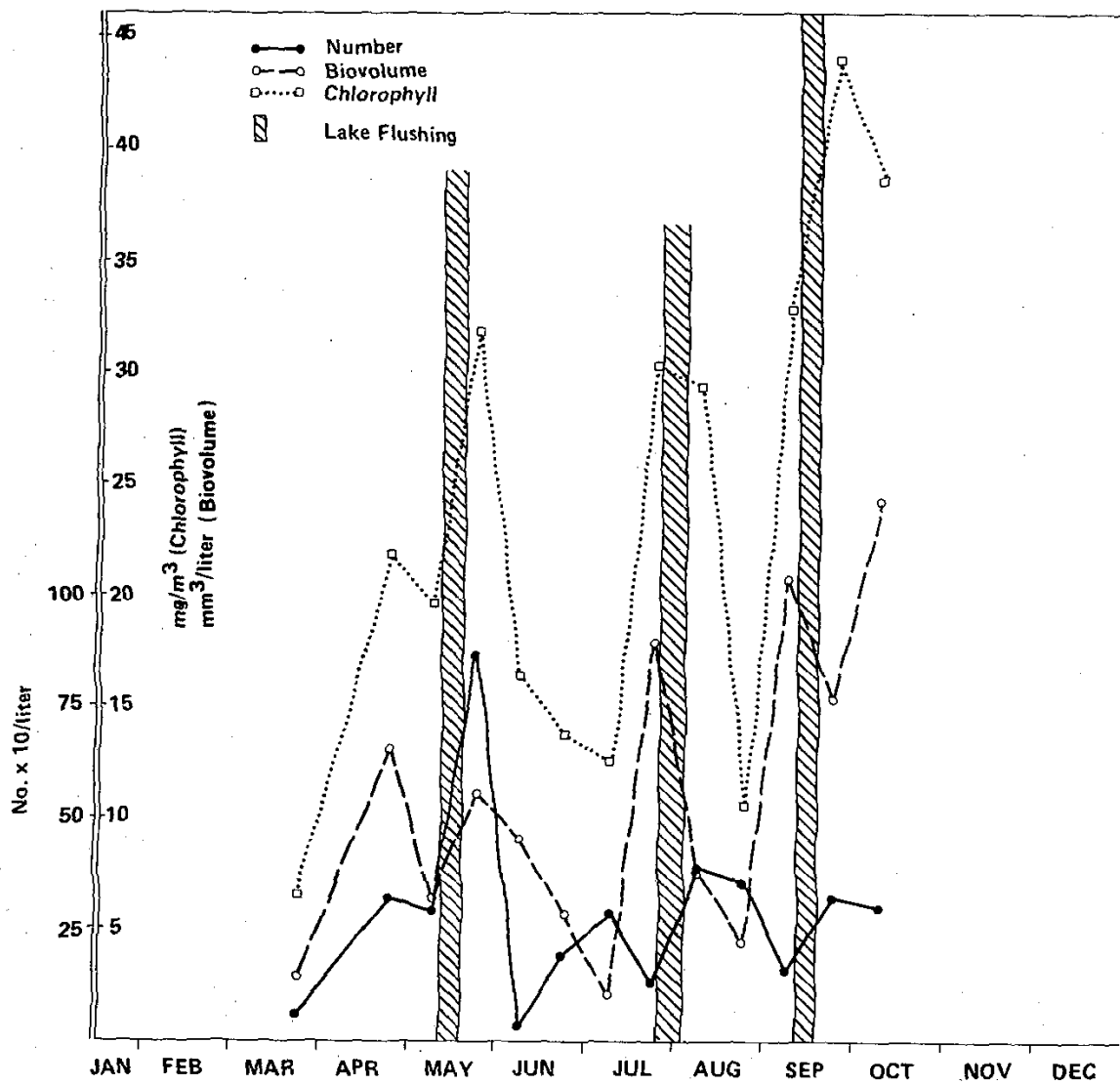

Figure 38
 AVERAGE ALGAL INDICATORS FOR ALL STATIONS

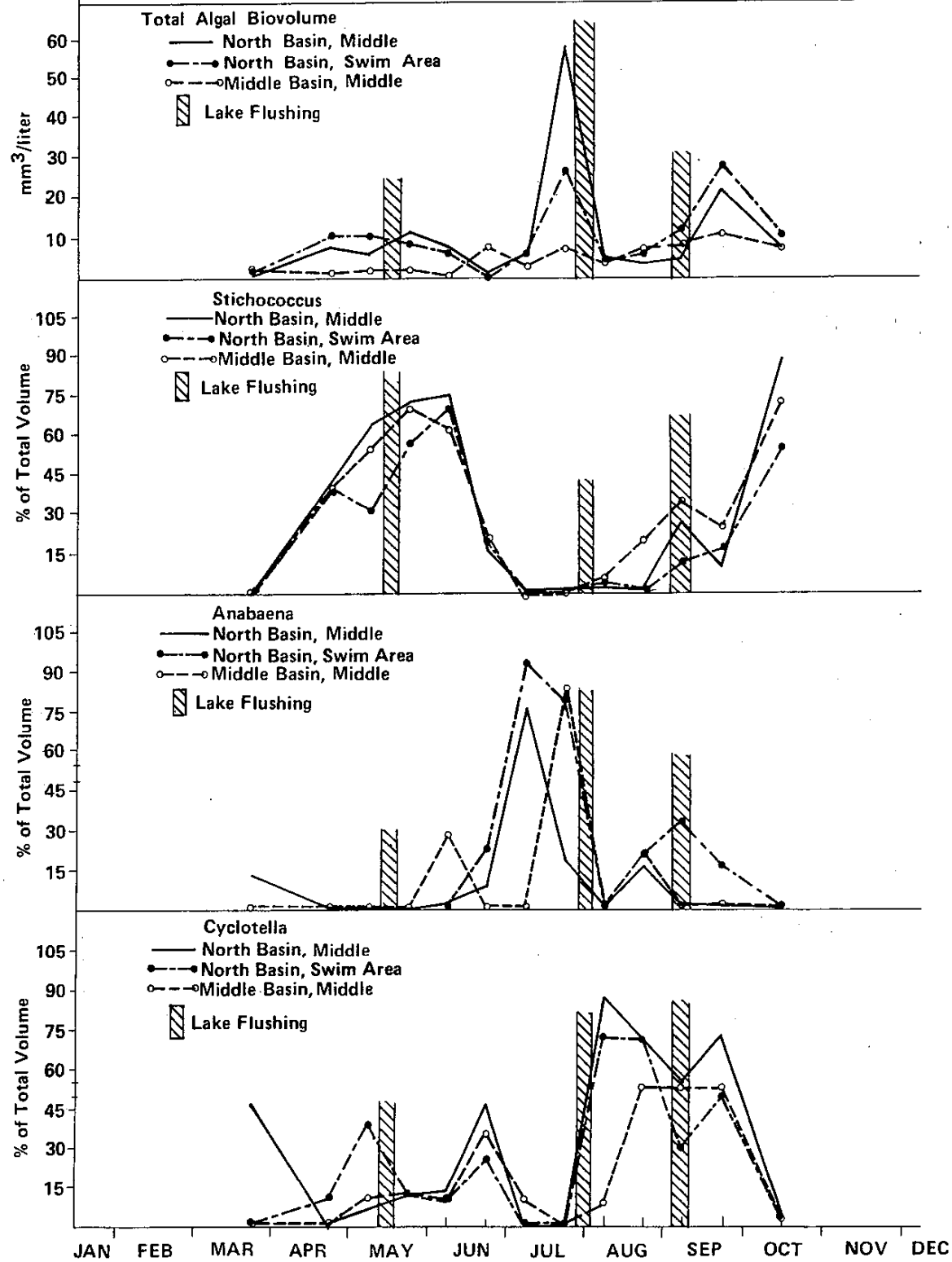

Figure 39

ALGAL BIOVOLUME AND DOMINANT SPECIES COMPOSITION

Kjeldahl nitrogen, low levels are probably due to decreased inputs through the growing season. Inorganic nitrogen and ortho-phosphate loading rates are also negatively correlated to algal parameters, showing that the rate of supply diminishes but algal volume and numbers can still increase. This means sufficient standing amounts of nutrients are available to supply the algae. Correlations to zooplankton densities are low and variable, indicating negligible algal control by grazing.

Zooplankton are important to assessments of eutrophication because of their role as algal grazers. They are difficult to use as indicators of lake nutrient status themselves because of the complexities of their competition and predation among species (Ref. 32, 33, 34). Three possible indicators are *Bosmina longirostris*, which can replace *B. coregoni* in enriched lakes (Ref. 35); *Trichocera cylindrica*, which often occurs during blue-green algal blooms; and *Chydorus sphaericus*, which also often blooms during blue-green algal blooms, although it is not a true plankton (Ref. 36). All these species occurred in Capitol Lake during the study (table 10).

Table 10. ZOOPLANKTON IDENTIFIED IN CAPITOL LAKE, 1977

Rotifera

<i>Asplanchna priodonta</i>	<i>Keratella cochlearis</i>
<i>Brachionus angularis</i>	<i>Keratella quadrata</i>
<i>Brachionus calycifloras</i>	<i>Keratella serrulata</i>
<i>Brachionus plicatilis</i>	<i>Lecance elasma</i>
<i>Brachionus quadridentata</i>	<i>Monostyla lunaris</i>
<i>Conochilus unicornis</i>	<i>Notholea</i> spp.
<i>Euchlaris</i> spp.	<i>Polyartha vulgaris</i>
<i>Filinia</i> spp.	<i>Synchaeta pectinata</i>
<i>Gastropus</i> spp.	<i>Trichocera cylindrica</i>
<i>Hexarthra mira</i>	<i>Trichocera multierinis</i>
<i>Kellicottia longisipina</i>	<i>Trichotria tetractis</i>

Copepoda

<i>Calanoid nauplii</i>	<i>Cyclops bicuspidatus thomasi</i>
<i>Canthocamptus</i> spp.	<i>Diaptomus</i> spp.
<i>Cyclopoid nauplii</i>	

Cladocera

<i>Bosmina longirostris</i>	<i>Daphnia pulex</i>
<i>Chydorus sphaericus</i>	

During March, zooplankton densities were low, and no species was dominant. This is typical in temperate zone lakes. Numbers began to increase slowly by April, particularly in the middle basin, and *Keratella*

cochlearis was dominant. Numbers increased further in May, with *Brachionus calycifloras* and *Bosmina longirostris* becoming prevalent.

The May flushing drastically reduced the zooplankton densities (figure 40). Densities remained low in May and 7 June, but reached high levels by 21 June, particularly in the swimming area when large numbers of *Brachionus calycifloras* and *Polyarthra vulgaris* were found. Densities remained high during July, with *Conochilus unicornus*, *Daphnia pulex*, *Bosmina longirostris* and, in late July, *Trichocera cylindrica* being dominant.

Again the lake was flushed, dramatically reducing the number of zooplankton, but by 23 August, large numbers of *Brachionus* had reappeared. Some of these rotifers can withstand high salinities, so that flushing may favor them. In early September numbers were again reduced after flushing, but remained low into October except for an increase of *Keratella serrulata* in the northern and middle basin.

It is difficult to fully assess zooplankton's role in Capitol Lake. The most numerous species are rotifers, which are too small to play a dominant role in algal grazing in eutrophic lakes (Ref. 37). Fish predation might be high because of salmonid-raising activities, but flushing appears to dominate zooplankton dynamics.

Bosmina coregoni was reported in 1955 (Ref. 38), while *B. longirostris* was reported in this study. This shift is reportedly a replacement phenomenon found when lakes become more eutrophic (Ref. 39), which suggests that the lake could be more enriched now than in 1955.

The levels of algae are typical of lakes receiving nutrient loadings as high as Capitol Lake. Conditions might be worse now than in 1955 and 1975, as indicated by the higher dominance of blue-green algae, particularly *Anabaena*, and the replacement of *B. coregoni* by *B. longirostris*. Chlorophyll levels during this study were within the range of the WSU study (Ref. 40), showing no indication of change. The concentrations observed are within the range of highly productive lakes (5 to 140 mg/m³ -- Ref. 41).

Blooms are apparently controlled very effectively by flushing, and introducing saltwater appears to be particularly effective in reducing *Anabaena*. The flushing increases transparency, as seen by the increase in Secchi depth readings.

ADDITIONAL WATER QUALITY PARAMETERS

In addition to the nutrients, bacteria, algae, and zooplankton discussed so far, Secchi depth, turbidity, dissolved oxygen, pH, temperature, specific conductance (conductivity), total solids, and suspended solids were measured during the study. These measurements, while adding to overall limnological understanding of Capitol Lake, are peripheral to the scope of work. They are discussed here briefly.

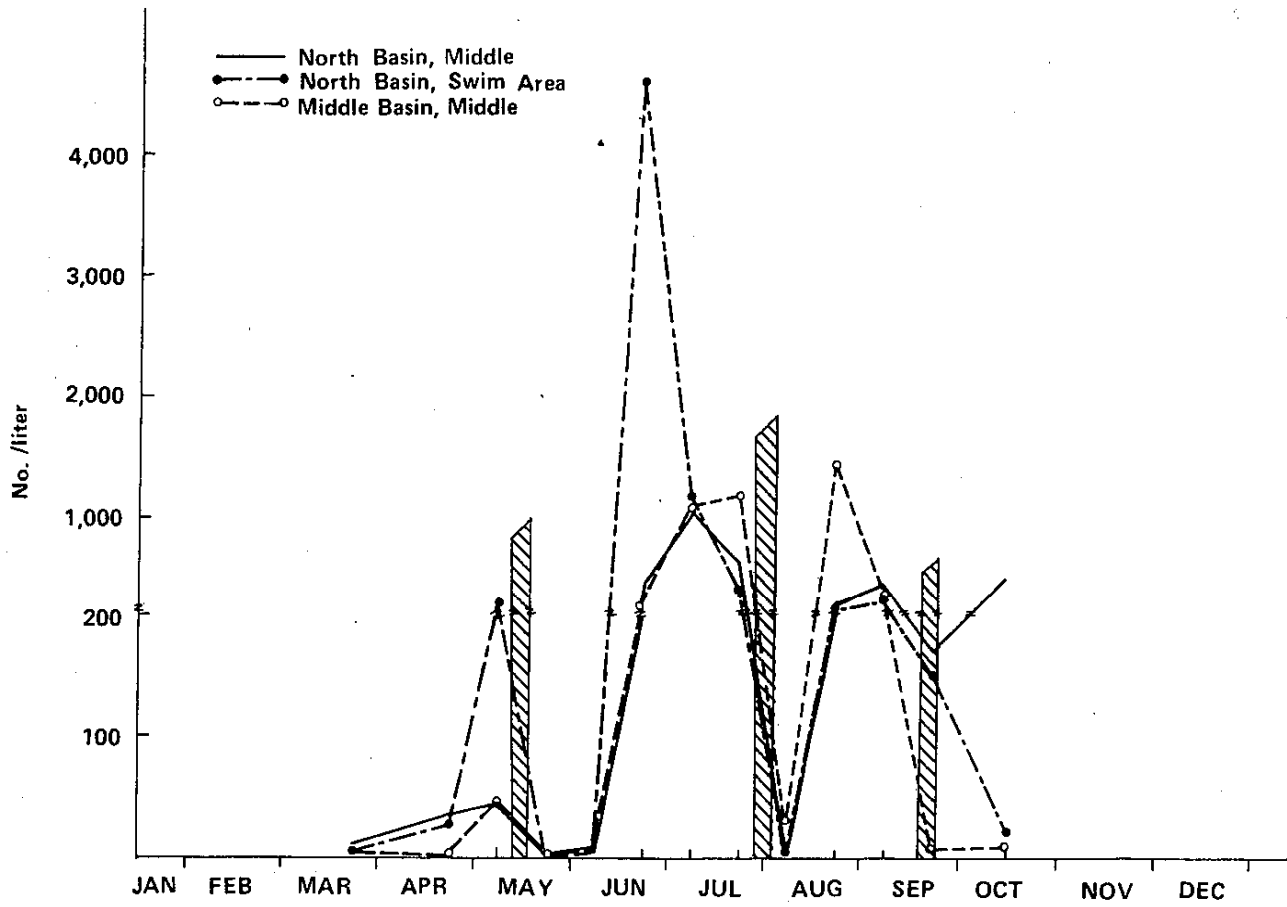

Figure 40
ZOOPLANKTON ABUNDANCE

Secchi depth is a measure of water clarity and is performed in the field. It is taken by measuring the depth at which a white disc disappears when lowered. The largest fluctuations of Secchi depth occurred in the south basin and were due to large influxes of suspended solids. This occurred in February, March, November, and December. Secchi depth was generally less in the north basin during the growing season, which reflects algal abundance. The general decrease in Secchi depth as water flows through the lake was also probably due to algal biomass. Flushing increased Secchi depth, as seen by the positive correlation between Secchi depth and conductivity during the summer (table 5). Secchi depths are plotted in figure 41.

Turbidity was fairly constant through most of the year except for increases during periods of high river discharge. During high inflow periods, turbidity decreased through the lake because sedimentation occurred in the south and middle basins (figure 41). The relationship of turbidity to suspended solids was shown in the WSU study.

Conductivity is a measure of ionic content. Sharp increases occurred during flushing (figure 41) because of inflowing seawater. Flushing caused the largest increases in the north basin and the smallest in the south. Conductivities generally returned to normal within 1 to 2 weeks after flushing. After the lake flushing, conductivity remained high in the north basin for 2 months. This is due either to low inflow or to some continuous intrusion of saltwater. Correlations of specific conductance to various other parameters during the summer are given in table 5.

To compensate for change in temperature, dissolved oxygen was converted to percent saturation by using the following equation (Ref. 42):

$$\% \text{ sat.} = 100 \times \frac{\text{Dissolved oxygen (mg/l)}}{14.161 - .3943 \text{ Temp} + .007714 (\text{Temp})^2 + .000646 (\text{Temp})^3}$$

Changes due to salinity were considered negligible.

Percent saturation is plotted in figure 41 for each basin. Although levels average near 100 percent, fluctuations above and below this occurred. During the summer, percent saturation decreased after each flushing, presumably because of algal die-off, and increased with the blooms between flushing. Drops in percent saturation were to as low as 50 percent.

Across the lake, percent saturation varied significantly at different stations. Duncan's test results in four overlapping subsets (appendix C). The most important comparisons were the low percent saturation at station 5 and high levels at station 8. Stations from the north basin were in the higher subsets, showing good average percent saturations in that basin.

On the average, oxygen levels are above the class A standard (8.0 mg/l). Individual stations, however, decreased to below 8.0 mg/l at times

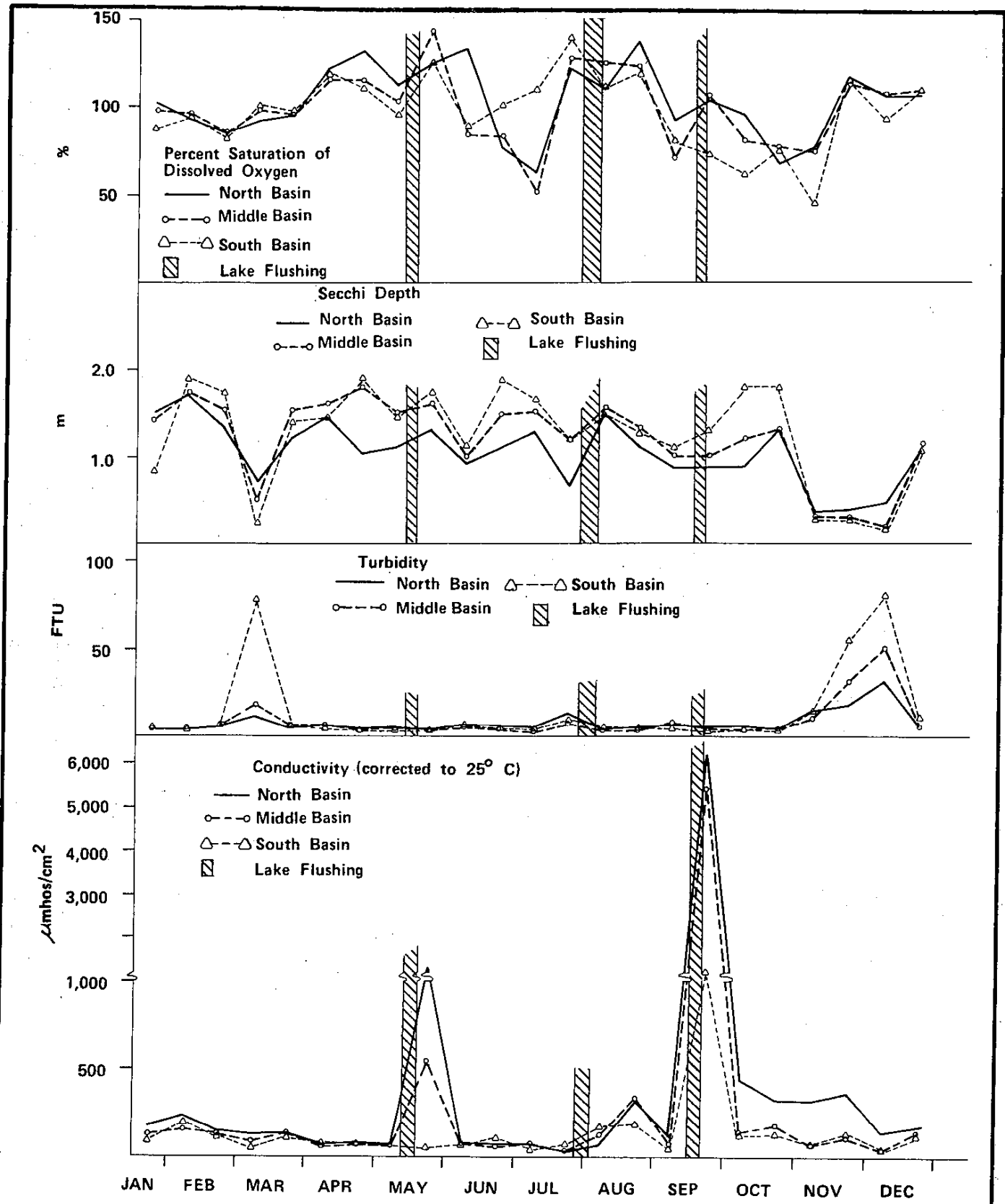

Figure 41
 PERCENT SATURATION, SECCHI DEPTH, TURBIDITY, AND CONDUCTIVITY

during June and July. These minimum values occurred after the first flushing of the lake and when retention time was high. The oxygen drop to below class A standards is most likely the result of algal and plant decay after flushing. The oxygen decrease after the next flushings is not as severe because of cooler temperatures and a shorter period between flushing, which probably allowed the September flushing to remove some of the decaying matter from the July flushing.

Figure 42 shows pH. The levels are within normal ranges for lakes, and generally are slightly alkaline. Increases of pH (presumably through photosynthetic activity) are apparently decreased by flushing.

Total solids follow a pattern very similar to conductivity (figure 42 for total solids, figure 41 for conductivity). Flushing dominates the changes of total solids during the growing season, with dramatic increases after each flushing.

Suspended solids (figure 42) are influenced by both sediment load of the Deschutes River (causing peaks in early March and in late November and December) and algal blooms. Increased levels of suspended solids occurred with each bloom, and decreases occurred with each flushing.

SWIMMING AREA

The statistical analysis of all water quality parameters showed that the swimming area (station 55) water quality is undistinguishable from that of the other lake stations. The circulation apparently is sufficient to prevent a local difference in this area.

Because of this lack of difference, no management plan specific to the swimming site is feasible. Strategies to control bacteria and algal growth in the whole lake will also control water quality in the swimming area.

Occasionally, mats of floating algae (*Anabaena*) might accumulate in the swimming area. This can happen in any section of the lake when wind conditions are conducive to concentrating the floating algae. *Anabaena* can be reduced in abundance by an increased flushing frequency, which would help prevent accumulation of algal mats anywhere in the lake.

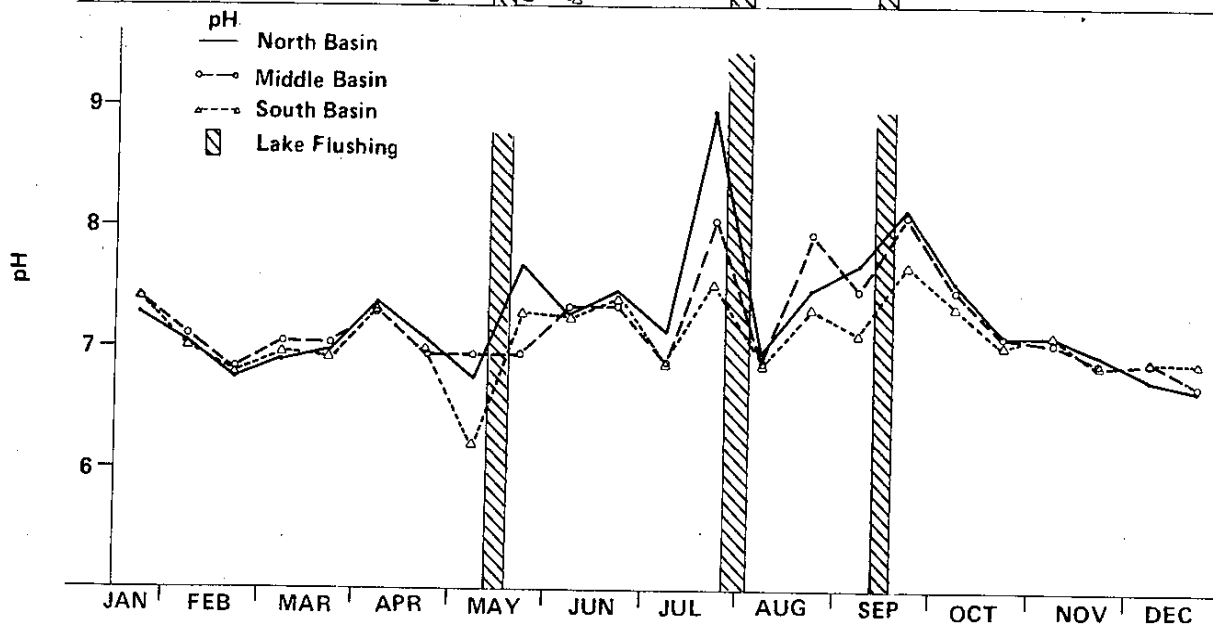
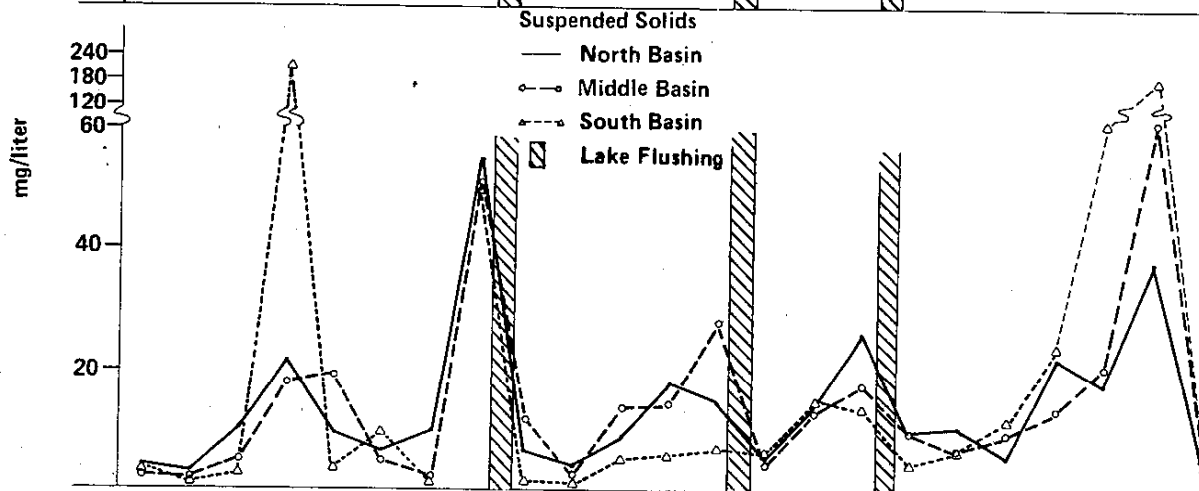
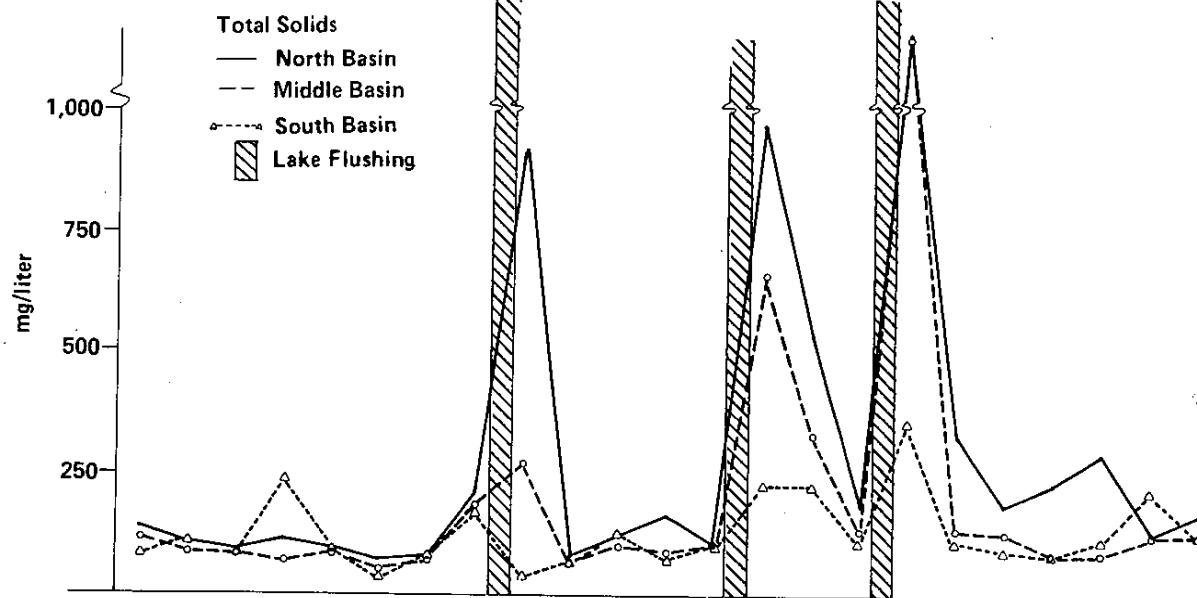

Figure 42
 TOTAL SOLIDS, SUSPENDED SOLIDS, AND pH



REFERENCES

1. Hydraulic and Water Quality Research
2. Evans, 1976
3. Ibid. 1977
4. Steel and Torrie
5. Nie et al.
6. ORANSCO
7. Lin et al.
8. ORANSCO, op cit.
9. Ibid.
10. Geldreich
11. Ibid.
12. Geldreich and Kenner
13. Geldreich et al.
14. Lin et al.
15. McFeters et al.
16. ORANSCO
17. McFeters et al.
18. Geldreich
19. Feachem, 1975
20. Feachem, 1974
21. Gates
22. Feachem, 1974
23. Municipality of Metropolitan Seattle
24. Evans, 1977
25. Geldreich
26. Hydraulic and Water Quality Research Studies
27. Vollenweider
28. Paulson
29. Chiaudini and Vighi
30. Greene et al.
31. Hydraulic and Water Quality Search Studies
32. Brooks and Dodson
33. Zaret
34. Dodson
35. Brooks
36. Hutchinson
37. Brooks
38. Engstrom-Heg
39. Brooks
40. Hydraulic and Water Quality Research Studies
41. Vollenweider
42. Perkins



BIBLIOGRAPHY

Brooks, J. L. Eutrophication and Changes in the Composition of the Zooplankton. *Eutrophication: Causes; Consequences; Correctives*. Washington, D.C.: National Academy of Sciences. 1969. pp. 236-255.

Brooks, J. L., and S. I. Dodson. Predation, Body Size, and Composition of Plankton. *Sci* 150:28-35 (1965).

Chiaudini, G., and M. Vighi. The N:P Ratio and Tests With *Selenastrum* to Predict Eutrophication in Lakes. *Water Res.* 8:1063-1069 (1974).

CH2M HILL. *Capitol Lake Restoration*. Draft Environmental Impact Statement. Olympia, Washington: Department of General Administration. 1976.

Dodson, S. I. Zooplankton Competition and Predation: An Experimental Test of the Size-Efficiency Hypothesis. *Ecology* 55:605-613 (1974).

Engstrom-Heg, R. *Environmental Relationships of Young Chinook Salmon in Capitol Lake and the Deschutes River System*. Cited in WSU 1975. State of Washington Department of Fisheries. 1955.

Evans, S. *Percival Cove Salmon Culture Activities, September 1974 to June 1975*. Progress Report #5. State of Washington Department of Fisheries. 1976.

———. *Percival Cove Salmon Culture Activities, September 1975 to June 1976*. Progress Report #28. State of Washington Department of Fisheries. 1977.

Feachem, R. Faecal Coliforms and Faecal Streptococci in Stream in the New Guinea Highlands. *Water Res.* 8:367-374 (1974).

———. An Improved Role for Faecal Coliform to Faecal Streptococci Ratios in the Differentiation Between Human and Non-human Pollution Sources. *Water Res.* 9:689-690 (1975).

Gates, C. D. *Treatment of Long Island Duck Farm Wastes*. New York State Water Pollution Control Board Res. Report No. 4. Albany, New York: New York State Department of Health. 1959.

Geldreich, E. E. Fecal Coliform Concepts in Stream Pollution. *Water and Sewage Works* 114:R98-R110 (1967).

Geldreich, E. E., et al. The Bacteriological Aspects of Stormwater Pollution. *J. Water Poll Contr Fed.* 40:1861-1871 (1968).

Geldreich, E. E., and B. A. Kenner. Concepts of Fecal Streptococci in Stream Pollution. *J. Water Poll Contr Fed.* 41 8J:R336-351 (1969).

- Greene, J. C., et al. Utilization of Algal Assays to Assess the Effects of Municipal, Industrial, and Agricultural Wastewater Effluents Upon Phytoplankton Production in the Snake River System. *Water Air Soil Pollution* 4:415-434 (1975).
- Hutchinson, G. E. *A Treatise on Limnology* Volume II. New York: John Wiley and Sons. 1967.
- Kramer, Chin and Mayo, Inc. *An Engineering Study of the Percival Creek Drainage Basin*. Olympia, Washington. 1973.
- Lin, S., R. L. Evans, and D. B. Beuscher. Bacteriological Assessment of Spoon River Water Quality. *Appl Microbiol* 28:288-297 (1974).
- Local Climatological Data*. Olympia, Washington: National Oceanographic and Atmospheric Administration. 1975.
- McFeters, G. A., et al. Comparative Survival of Indicator Bacteria and Enteric Pathogens in Well Water. *Appl Microbiology* 27:823-829 (1974).
- Municipality of Metropolitan Seattle. *Maximizing Storage in Combined Sewer Systems*. Environmental Protection Agency, Proj. No. 11022 ELK. 1971.
- Nie, N. H., et al. *SPSS. Statistical Package for the Social Sciences*. San Francisco: McGraw-Hill. 1975.
- ORANSCO. Total Coliform: Fecal Coliform Ratio for Evaluation of Raw Water Bacteriological Quality. *J Water Poll Cont Fed* 43:630-640 (1971).
- Orsborn, J. F. *Supplemental Sediment Tests of Capitol Lake Hydraulic Model*. State of Washington Department of General Administration. 1976.
- Paulson, L. J. The Significance of Ammonia Regeneration by Trout on Phytoplankton Productivity in Castle Lake, California. Ph. D. Thesis, University of California, Davis. 1977.
- Perkins, E. S. *The Biology of Estuaries and Coastal Waters*. New York: Academic Press. 1974.
- Saving a Beautiful Lake*. Olympia, Washington: Capitol Lake Committee. 1974.
- Steel, R. G. D., and J. H. Torrie. *Principles and Procedures of Statistics*. New York: McGraw-Hill. 1960.
- Vollenweider, R. A. *Scientific Fundamentals of the Eutrophication of Lakes and Flowing Waters, With Particular Relevance to Nitrogen and Phosphorus as Factors in Eutrophication*. O.E.C.D. Davis, California. 1968.

Washington State University, College of Engineering. *Hydraulic and Water Quality Research Studies of Capitol Lake Sediment and Restoration Problems*. Olympia, Washington: State of Washington Department of General Administration. 1975.

Zaret, T. M. Predators, Invisible Prey and the Nature of Polymorphism in the Cladocera (Class Crustacea). *Limnol Oceanog* 17:171-184 (1972).

Appendix A
Description of
Synoptic Stations

 Appendix A
 DESCRIPTION OF SYNOPTIC STATIONS

All shoreline samples collected 50 feet off shore.

Station Numbers	Station Description
1.	Straight out 50 feet from east side of show K.F.C.
2.	Buoy for anchoring logs in front of dam.
3.	50 feet south of No. 4 Buoy Station. Swimming area. Boom Log, has bird fecal matter.
4.	50 feet east of Buoy 50 feet off shoreline.
5.	50 feet off shoreline for sailing prams--drain pipe of some kind.
6.	2 feet off dock by shed.
7.	50 feet off end of parking lot (south end).
8.	70 feet off shoreline, single evergreen on shore.
9.	RR ties on shore sample 50 feet off shore.
10.	Telephone pole and RR line switcher 50 feet from shoreline.
11.	Straight out from RR switch pole in line just before curve on road.
12.	250 feet midpoint in channel due N of #13.
13.	50 feet north of walk bridge midpoint of channel for bridge.
14.	50 feet off midpoint of park north.
15.	50 feet off mailboxes and shrubs change.
16.	Shrub change--new building in background--50 feet just before bus stop shelf.
17.	50 feet shrub bunches and bench.
18.	50 feet of south shrubbery change back from bunches to scotch broom.
19.	10 feet off south side of RR bridge; ice on surface.
20.	100 feet off third telephone pole from RR bridge.
21.	Outside Deschutes Parkway bridge, midstream.
22.	First manhole cover along RR track.
23.	West exit of Percival Cove outlet south side.
24.	Taken off end of Fishers in Percival Cove.
25.	Sample salmon shack 50 feet off cattails.
26.	Midlake due east of 25.
27.	140 feet off shore on shoreline by old fir in shallow.
27A.	Due east of Greenwood Drive 30 feet off shore.
28.	Midpoint between 27A and 29 Road (Greenwood Drive and boathouse).
29.	20 feet off boathouse and dock.
30.	Maple tree 30 feet off cattails.
31.	Middle point between 32 and 30.
32.	100 feet off point.
33.	Evergreen delta.
34.	Midpoint east. Straight at hangar seaplane (being demolished).
35.	35 feet off piling.

36. 50 feet off I-5 interchange discharge (grid on culvert).
37. Midpoint brush in lake due southwest to midpoint of skiing beach.
38. Clump of large fir on hillside 500 feet south of snaggy very tall dying fir.
39. 50 feet off large fir on immediate shoreline.
40. 50 feet off shore due west of drifting dried weed and brushy-looking stumps.
41. Next to piling; 50 feet off shore.
42. Midway between two deadheads.
43. Mouth north of I-5 bridge west side of channel 70 feet off shore.
44. 100 feet south of I-5 bridge, midchannel.
45. First channel midpoint 70 feet off I-5 shoreline.
46. 200 feet out in channel from boat launch ramp.
47. 7 feet off sandbar in park at fish pond outflow.
48. New Olympia Brewery bridge.
49. Tumwater Valley bridge.
50. Middle of lake.
51. Storm outfall-sample taken 1/2 in lake and 1/2 from small trickle of discharge--looks like natural load where water is trickling. Algae thick in spots.
52. Greenwood Inn drainage culvert 36-inch diameter 180 yards due north of station 54. Directly above on the hill (180-230 elevation) is the Greenwood Inn.
53. Water level 36-inch culvert 80 feet north of artesian flowing well in the lake. This culvert is submerged and samples have never been taken.
54. Olympia-Tumwater freeway. Storm-rain runoff drain. Northernmost end of the grassy skiing park. A heavy grill covers a 36-inch culvert.
55. In Capitol Lake swimming area inside the enclosed area off the docks between the two diving boards.
56. Saltwater station, samples taken off the end of the Olympia Marina visitors' dock (northernmost end).
57. 200 yards along the east bank of the railroad marshaling yard from the Burlington Northern Station. Samples taken before water runs into a sump then a culvert which appears to be draining into the lake.
58. 100 yards south of station 57 and 50 feet south of railroad yard work shack.
59. Saltwater station, the northwestern float of the Olympia Yacht Club.

Appendix B
Data Analysis
and Reports



1450 114th AVENUE S.E., SUITE 120 • BELLEVUE, WASHINGTON 98004 • 206/453-5260

SEDIMENT ANALYSIS REPORT

CLIENT: DOE, Capitol Lake

DATE SAMPLED: September 27, 1977

REPORT TO: Constantin Zadorojny

DATE REPORTED: October 17, 1977

JOB NO.: S.10583.A6

Laboratory Station Sample No. Number	Total Coliform Range (MPN/g dry sediment)	Fecal Coliform Range (MPN/g dry sediment)	Fecal Streptococci Range (MPN/g dry sediment)
2895 7	410	<8	1600
2896 14	2300-3400	2300-3400	4300-5200
2897 24	1300-1500	12	1300-2200
2898 28	610-1000	28	740-1800
2899 32	4200-4400	220	510-620
2900 46	1200-1800	55	350-910
2901 55	1100-1600	32-37	6600-8600

Method adopted from APHA Recommended Procedures for the Examination of Seawater and Shellfish, Fourth Edition, 1970, p. 40-46.

REPORTED BY

Jan Kroum
Jan Kroum

Microbiologist

ANALYSIS REPORT

CLIENT: CH2M HILL (Capital Lake)

DATE REPORTED: 1-17-78

REPORT TO: Rod Hoffman

JOB NUMBER: S10583.A6

<u>SAMPLE NO.</u>	<u>SAMPLE DESCRIPTION</u>	<u>% MOISTURE</u>	<u>NO₂NO₃-N (mg/g)</u>	<u>Total-P (mg/g)</u>	<u>NH₃-N (mg/g)</u>	<u>Kjeldah Nitroge: (mg/g)</u>
4480	Coot droppings	86.	.02	.56	1.2	4.0
4481	Goose "	82.	.002	.82	.64	4.7
4482	Duck "	78.	.01	.44	1.2	5.1

REPORTED BY

Michael J. Eickman

SAMPLE ANALYSIS REPORT

CLIENT: Capitol Lake, DOE

DATE SAMPLED: Dec. 27, 1977

REPORT TO: Constantin Zadorojny

DATE REPORTED: Jan. 10, 1978

All samples collected December 27, 1977 and incubated at 20°C until inoculated. (Each sample shaken daily) Once inoculated, samples are analyzed according to Standard Methods, 14th Edition.

Lab Sample Number	Station Number	Total Coliform (MPN/100mls)	Fecal Coliform (MPN/100mls)	Fecal Streptococci (MPN/100mls)	FC/FS Ratio
-------------------------	-------------------	-----------------------------------	-----------------------------------	---------------------------------------	----------------

Date inoculated December 27, 1977

4283	5	1,700	20	490	0.04
4290	22	230	45	430	0.10
4292	24	230	<20	230	-
4293	28	490	20	230	0.09
4298	46	1,100	310	2,400	0.13
4299	47	16,000	5,400	>24,000	-
4300	50	490	78	490	0.16

Date inoculated December 29, 1977

4283	5	2,400	20	<20	-
4290	22	490	20	45	0.44
4292	24	330	<20	<20	-
4293	28	1,300	20	130	0.15
4298	46	2,200	170	330	0.5
4299	47	2,200	310	490	0.63
4300	50	2,400	78	68	1.15

Date inoculated December 31, 1977

4283	5	110	2	<2	-
4290	22	23	5	11	0.45
4292	24	23	5	2	2.5
4293	28	49	6	6	1.0
4298	46	350	49	170	0.29
4299	47	49	11	240	0.05
4300	50	540	33	33	1.0

cont.

AT

Lab Sample Number	Station Number	Total Coliform (MPN/100mls)	Fecal Coliform (MPN/100mls)	Fecal Streptococci (MPN/100mls)	FC/Fs Ratio
-------------------------	-------------------	-----------------------------------	-----------------------------------	---------------------------------------	----------------

Date inoculated January 2, 1978

4283	5	79	<2	<2	-
4290	22	7	<2	4	-
4292	24	23	<2	<2	-
4293	28	23	<2	<2	-
4298	46	23	<2	23	-
4299	47	33	<2	9	-
4300	50	240	<2	23	-

Date inoculated Jan. 4, 1978

4283	5	33	<2	<2	-
4290	22	7	<2	4	-
4292	24	13	<2	<2	-
4293	28	17	<2	<2	-
4298	46	33	<2	8	-
4299	47	23	<2	5	-
4300	50	70	<2	8	-

REPORTED BY

Jan KroumJan Kroum
Microbiologist

AT am test inc.

1450 114th AVENUE S.E., SUITE 120 • BELLEVUE, WASHINGTON 98004 • 206/453-5280

SAMPLE ANALYSIS REPORT

CLIENT: Capitol Lake

JOB NUMBER: S10583.A6

REPORT TO: Rod Hoffman

DATE SAMPLED: Jan. 13, 1978

DATE REPORTED: Jan. 17, 1978

<u>LABORATORY SAMPLE NO.</u>	<u>CLIENT'S DESIGNA- TION</u>	<u>NO. OF SAMPLES</u>	<u>TOTAL COLIFORM (MPN/100 gms)Ø</u>	<u>FECAL COLIFORM (MPN/100 gms)Ø</u>	<u>FECAL STREPTC (MPN/100 gñ</u>
4490	Coot	3	54,000,000	54,000,000	560,000
4481	Goose	2	1,400,000	950,000	1,300,000
4482	Duck	4	28,000,000	1,300,000	4,900,000
			27,800,000 ^a	19,000,000 ^a	22,000,000 ^a
			26,300,000 ^b	30,000,000 ^b	2,300,000 ^b

Ø MPN/100 g wet weight

^a Mean

^b Standard deviation

REPORTED BY

Jan Kroum

Jan Kroum
Microbiologist

ANALYSIS REPORT

CLIENT: CH2M HILL (Capital Lake) DATE REPORTED: Jan. 12, 1978
REPORT TO: Rod Hoffman JOB NUMBER: S10583.A6

The analysis of fish food used at Capital Lake is as follows:

	<u>Sample 4249</u> <u>Fish Food</u>
Phosphate as P	69.4 mg/g
Kjeldahl Nitrogen as N	11.8 mg/g
Nitrate + Nitrite as N	<.0005 mg/g
Ammonia as N	3.1 mg/g

REPORTED BY

Michael J. Behrman

Appendix C
Statistical
Analysis

Lakefair Sampling

Turbidity by Station

SOURCE	SUM OF SQ.	D.F.	MEAN SQ.	F	PROB
BETWEEN	29290.21	18	1627.	0.8911	0.5962
WITHIN	29217.86	16	1826.		
TOTAL	58508.07	34			

Fecal Coliform by Station

SOURCE	SUM OF SQ.	D.F.	MEAN SQ.	F	PROB
BETWEEN	0.1981511E+10	18	.1101E+09	0.9701	0.5284
WITHIN	0.1815617E+10	16	.1135E+09		
TOTAL	0.3797128E+10	34			

Total Coliform by Station

SOURCE	SUM OF SQ.	D.F.	MEAN SQ.	F	PROB
BETWEEN	7646320.	18	.4248E+06	3.252	0.0109
WITHIN	2090233.	16	.1306E+06		
TOTAL	9736552.	34			

Fecal Streptococci by Station

SOURCE	SUM OF SQ.	D.F.	MEAN SQ.	F	PROB
BETWEEN	245695.7	18	.1365E+05	0.4669	0.9391
WITHIN	467781.0	16	.2924E+05		
TOTAL	713476.7	34			

Fecal Coliforms/Fecal Streptococci by Station

SOURCE	SUM OF SQ.	D.F.	MEAN SQ.	F	PROB
BETWEEN	239.3361	18	13.30	0.3812	0.9574
WITHIN	279.0189	8	34.88		
TOTAL	518.3550	26			

Intensive Surveys

Turbidity Analyzed by Station

SOURCE	SUM OF SQ.	D.F.	MEAN SQ.	F	PROB
BETWEEN	23307.40	48	485.6	0.4004	0.9934
WITHIN	20617.09	17	1213.		
TOTAL	43924.49	65			

Total Coliform Analyzed by Station

SOURCE	SUM OF SQ.	D.F.	MEAN SQ.	F	PROB
BETWEEN	0.2450469E+08	48	.5105E+06	0.7345	0.8018
WITHIN	0.1181536E+08	17	.6950E+06		
TOTAL	0.3632005E+08	65			

Fecal Coliform Analyzed by Station

SOURCE	SUM OF SQ.	D.F.	MEAN SQ.	F	PROB
BETWEEN	1206548.	48	.2514E+05	0.5727	0.9338
WITHIN	746210.5	17	.4389E+05		
TOTAL	1952758.	65			

Fecal Streptococci by Station

SOURCE	SUM OF SQ.	D.F.	MEAN SQ.	F	PROB
BETWEEN	0.2117392E+08	48	.4411E+06	0.6172	0.9040
WITHIN	0.1214935E+08	17	.7147E+06		
TOTAL	0.3332327E+08	65			

Fecal Coliform/Fecal Streptococci by Station

SOURCE	SUM OF SQ.	D.F.	MEAN SQ.	F	PROB
BETWEEN	12.97419	48	.2703	0.3644	0.9969
WITHIN	12.60880	17	.7417		
TOTAL	25.58299	65			

Analysis of Variance on Organism Data

Algal Number

SOURCE	SUM OF SQ.	D.F.	MEAN SQ.	F	PROB
BETWEEN	217.6055	3	72.54	0.8791E-01	0.9663
WITHIN	39603.14	48	825.1		
TOTAL	39820.75	51			

Algal Biovolumes

SOURCE	SUM OF SQ.	D.F.	MEAN SQ.	F	PROB
BETWEEN	433.7529	3	144.6	1.429	0.2459
WITHIN	4857.205	48	101.2		
TOTAL	5290.958	51			

Chlorophyll-a (uncorrected for phaeophytin)

SOURCE	SUM OF SQ.	D.F.	MEAN SQ.	F	PROB
BETWEEN	12.06152	3	4.021	0.1699E-01	0.9969
WITHIN	11355.63	48	236.6		
TOTAL	11367.69	51			

Zooplankton Numbers

SOURCE	SUM OF SQ.	D.F.	MEAN SQ.	F	PROB
BETWEEN	486825.9	3	.1623E+06	0.2897	0.8326
WITHIN	0.2688437E+08	48	.5601E+06		
TOTAL	0.2737119E+08	51			

The stations were recorded in the following analysis as follows:

<u>Printout Number</u>	<u>Station Number</u>
1	2
2	5
3	6
4	8
5	10
6	13
7	14
8	18
9	22
10	23
11	24
12	28
13	32
14	35
15	39
16	43
17	46
18	47
19	50
20	51
21	52
22	54
23	55
24	57
25	59

..... O N E W A Y

VARIABLE TC01 (Total Coliform)

ANALYSIS OF VARIANCE

SOURCE	D.F.	SUM OF SQUARES	MEAN SQUARES	F RATIO	F PROB.
BETWEEN GROUPS	24	2035101933.9520	84795913.9144	5.906	<0.0000
WITHIN GROUPS	531	7620844326.2464	14352060.8781		
TOTAL	555	9656046260.2792			

SUBSET 1

GROUP	GRP23	GRP10	GRP24	GRP 7	GRP11	GRP 9	GRP19	GRP 4
MEAN	341.0417	364.9167	439.5000	448.6250	484.0000	488.2500	610.0833	661.0833
GROUP	GRP21	GRP 5	GRP 8	GRP 1	GRP22	GRP06	GRP12	GRP 3
MEAN	667.9565	760.8333	794.3750	873.0970	1131.2500	1268.8750	1286.8750	1557.3750
GROUP	GRP13	GRP14	GRP15	GRP14	GRP25			
MEAN	1558.7500	1695.4167	2016.7500	2250.9167	2553.9444			

SUBSET 2

GROUP	GRP15	GRP14	GRP25	GRP18
MEAN	2016.7500	2250.9167	2553.9444	4234.0000

SUBSET 3

GROUP	GRP25	GRP16	GRP17
MEAN	2553.9444	4234.0000	4662.8750

SUBSET 4

GROUP	GRP14	GRP17	GRP20
MEAN	4234.0000	4662.8750	7711.8333

SUBSET 5

GROUP	GRP20	GRP 2
MEAN	7711.8333	9009.5000

FILE RODS (CREATION DATE = 02/26/78) STUDY

..... O N E M A Y

VARIABLE AMM (Ammonia-N)

ANALYSIS OF VARIANCE

SOURCE D.F. SUM OF SQUARES MEAN SQUARES F RATIO F PROB.

BETWEEN GROUPS 24 6.3905 0.2663 4.193 0.0000

WITHIN GROUPS 525 33.3426 0.0635

TOTAL 549 39.7330

SUBSET 1

GROUP MEAN	GRP21 0.0177	GRP15 0.0188	GRP13 0.0192	GRP14 0.0196	GRP17 0.0204	GRP 1 0.0213	GRP 4 0.0221	GRP25 0.0225
GROUP MEAN	GRP27 0.0225	GRP19 0.0226	GRP26 0.0226	GRP12 0.0233	GRP16 0.0233	GRP23 0.0235	GRP2A 0.0236	GRP1A 0.0246
GROUP MEAN	GRP29 0.0258	GRP24 0.0330	GRP22 0.0396	GRP11 0.0538	GRP 3 0.0475	GRP10 0.0504	GRP20 0.1020	GRP24 0.2000

SUBSET 2

GROUP MEAN
GRP 7
0.5805

FILE R005 (CREATION DATE = 02/26/78) STUDY

..... D N E M A Y

VARIABLE NITP (Nitrate-N)

ANALYSIS OF VARIANCE

SOURCE D.F. SUM OF SQUARES MEAN SQUARES F RATIO F PROB.

BETWEEN GROUPS 24 10.8173 0.4507 5.180 0.0000

WITHIN GROUPS 526 45.7693 0.0870

TOTAL 550 56.5866

SUBSET 1

GROUP GRP24 GRP25 GRP 2 GRP 10 GRP11 GRP 3 GRP 1 GRP23
MEAN 0.0860 0.1344 0.1600 0.1646 0.1650 0.1792 0.1842 0.1828GROUP GRP 4 GRP 8 GRP 5 GRP 7 GRP 6 GRP19 GRP12 GRP13
MEAN 0.1858 0.1642 0.1867 0.1883 0.1905 0.2013 0.2083 0.2113GROUP GRP14 GRP15 GRP 9 GRP16 GRP22 GRP17 GRP18
MEAN 0.2168 0.2375 0.2638 0.2671 0.2883 0.2971 0.3333

SUBSET 2

GROUP GRP21
MEAN 0.15986

SUBSET 3

GROUP GRP20
MEAN 1.3480

FILE RODS (CREATION DATE = 02/26/78) STUDY

..... O N E M A Y

VARIABLE ORTH (Ortho-phosphate)

ANALYSIS OF VARIANCE

SOURCE	D.F.	SUM OF SQUARES	MEAN SQUARES	F RATIO	F PROB.
BETWEEN GROUPS	24	0.5082	0.0210	4.639	0.0000
WITHIN GROUPS	526	2.3819	0.0045		
TOTAL	550	2.8861			

SUBSET 1

GROUP MEAN	GRP13	0.0146	GRP15	0.0163	GRP16	0.0163	GRP23	0.0165	GRP14	0.0167	GRP12	0.0175	GRP21	0.0177	GRP18	0.0183
GROUP MEAN	GRP 9	0.0188	GRP 6	0.0196	GRP 5	0.0196	GRP 7	0.0196	GRP24	0.0204	GRP11	0.0217	GRP18	0.0221	GRP19	0.0230
GROUP MEAN	GRP22	0.0235	GRP 1	0.0246	GRP10	0.0275	GRP17	0.0304	GRP25	0.0583	GRP23	0.0613	GRP20	0.0900		

SUBSET 2

GROUP MEAN	GRP25	0.0583	GRP 3	0.0613	GRP20	0.0900	GRP24	0.1110
------------	-------	--------	-------	--------	-------	--------	-------	--------

SUBSET 3

GROUP MEAN	GRP20	0.0900	GRP24	0.1110	GRP 2	0.1585
------------	-------	--------	-------	--------	-------	--------

FILE RODS (CREATION DATE = 02/26/78) STUDY

..... ONEWAY

VARIABLE KNO (Kjeldahl Nitrogen)

ANALYSIS OF VARIANCE

SOURCE	D.F.	SUM OF SQUARES	MEAN SQUARES	F RATIO	F PROB.
BETWEEN GROUPS	24	557.4622	23.2276	1.383	0.1074
WITHIN GROUPS	513	8616.7616	16.7968		
TOTAL	537	9174.2240			

SUBSET 1

GROUP MEAN	GRP 15	0.2248	GRP 21	0.2276	GRP 14	0.2404	GRP 16	0.2522	GRP 18	0.2639	GRP 1	0.2742	GRP 13	0.2821	GRP 19	0.2838
GROUP MEAN	GRP 17	0.2896	GRP 4	0.3017	GRP 12	0.3025	GRP 8	0.3175	GRP 7	0.3283	GRP 5	0.3317	GRP 6	0.3378	GRP 22	0.3391
GROUP MEAN	GRP 3	0.3729	GRP 9	0.3859	GRP 24	0.4311	GRP 20	0.4320	GRP 11	0.5071	GRP 25	0.5600	GRP 23	1.3332	GRP 10	1.5363

SUBSET 2

GROUP MEAN	GRP 2	5.5250
------------	-------	--------

FILE RODS (CREATION DATE = 02/26/78) STUDY

..... O N E M A Y

VARIABLE TPHO (Total phosphate)

ANALYSIS OF VARIANCE

SOURCE D.F. SUM OF SQUARES MEAN SQUARES F RATIO F PROB.

BETWEEN GROUPS 24 1.4613 0.0609 2.375 0.0001

WITHIN GROUPS 515 12.1762 0.0236

TOTAL 539 13.6376

SUBSET 1

GROUP GRP21 GRP14 GRP15 GRP18 GRP19 GRP28 GRP13 GRP9
 MEAN 0.0305 0.0375 0.0388 0.0391 0.0395 0.0438 0.0438 0.0454

GROUP GRP22 GRP16 GRP5 GRP6 GRP7 GRP12 GRP17 GRP23
 MEAN 0.0459 0.0461 0.0483 0.0486 0.0496 0.0500 0.0513 0.0557

GROUP GRP4 GRP11 GRP1 GRP3 GRP25 GRP24 GRP10 GRP20
 MEAN 0.0560 0.0563 0.0574 0.0592 0.1100 0.1430 0.1442 0.1560

SUBSET 2

GROUP GRP20 GRP2
 MEAN 0.1560 0.2926

FILE RODS (CRFATION DATE = 02/26/78) STUDY

..... D N E M A Y

VARIABLE FCOFS (Fecal coliform: fecal streptococci ratio)

ANALYSIS OF VARIANCE

SOURCE D.F. SUM OF SQUARES MEAN SQUARES F RATIO F PROB.

BETWEEN GROUPS 24 1809.6579 75.4024 0.794 0.7463

WITHIN GROUPS 529 50239.5590 94.9708

TOTAL 553 52049.2169

SUBSET 1

GROUP MEAN	GRP24 0.7631	GRP11 0.7798	GRP22 0.9420	GRP10 0.9866	GRP18 1.0404	GRP 9 1.4298	GRP19 1.5498	GRP20 1.7617
GROUP MEAN	GRP16 2.0817	GRP 4 2.7389	GRP12 3.2584	GRP13 3.2707	GRP 2 3.8161	GRP15 3.9664	GRP23 4.0152	GRP 1 4.0209
GROUP MEAN	GRP 3 4.2217	GRP 7 4.5854	GRP 5 5.1292	GRP21 5.2871	GRP14 5.5182	GRP17 5.5720	GRP 6 5.8268	GRP A 6.1215
GROUP MEAN	GRP25 6.2707							

FILE RDDS (CREATION DATE = 02/26/78) STUDY

..... D N E W A Y

VARIABLE TS (Total Solids)

ANALYSIS OF VARIANCE

SOURCE D.F. SUM OF SQUARES MEAN SQUARES F RATIO F-PROB.

BETWEEN GROUPS 24 11515488814.9760 479812017.2928 289.810 0.0000

WITHIN GROUPS 533 882839718.8048 1655609.2282

TOTAL 557 12397928133.6320

SUBSET 1

GROUP GRP22 GRP21 GRP17 GRP20 GRP16 GRP18 GRP 2 GRP11
 MEAN 81.8458 95.7391 123.3542 125.6667 136.3750 142.1042 193.9286 196.1667

GROUP GRP10 GRP24 GRP14 GRP12 GRP15 GRP 6 GRP 7 GRP17
 MEAN 206.9792 264.2000 297.3750 316.8750 333.4167 335.5017 349.5042 351.5817

GROUP GRP 9 GRP 1 GRP19 GRP 8 GRP24 GRP 5 GRP23
 MEAN 352.8125 427.6042 442.5817 474.1667 487.8083 493.2917 515.1458

SUBSET 2

GROUP GRP25
 MEAN 26008.7778

FILE R005 (CREATION DATE = 02/26/78) STUDY

***** O N E M A Y *****

VARIABLE SUS (Suspended Solids)

ANALYSIS OF VARIANCE

SOURCE	D.F.	SUM OF SQUARES	MEAN SQUARES	F RATIO	F PROB.
BETWEEN GROUPS	24	33979.8781	1415.8281	1.134	0.2999
WITHIN GROUPS	533	665194.0189	1248.0188		
TOTAL	557	699173.8930			

SUBSET 1

GROUP MEAN	GRP20 9.9147	GRP22 9.9375	GRP 6 11.8167	GRP13 12.3956	GRP 4 12.7042	GRP23 13.1042	GRP11 13.5000	GRP19 13.5750
GROUP MEAN	GRP 1 13.6875	GRP 8 13.7792	GRP14 13.9625	GRP 7 15.1250	GRP 3 15.9792	GRP12 16.3750	GRP 9 17.5417	GRP15 17.7292
GROUP MEAN	GRP21 18.4696	GRP 5 19.2917	GRP25 19.7667	GRP16 24.6333	GRP18 25.1792	GRP 2 25.7762	GRP17 31.0625	GRP10 38.1833
GROUP MEAN	GRP24 48.0000							

FILE RODS (CREATION DATE = 02/26/78) STUDY

..... 0 N E W A Y

VARIABLE FSTP (Fecal Streptococci)

ANALYSIS OF VARIANCE

SOURCE	D.F.	SUM OF SQUARES	MEAN SQUARES	F RATIO	F PROB.
BETWEEN GROUPS	24	757733164.0704	31572215.1697	4.068	0.0000
WITHIN GROUPS	530	4113453171.0976	7761232.3983		
TOTAL	554	4871683351808			

SURSET 1

GROUP	GRP 6	GRP23	GRP 5	GRP22	GRP19	GRP16	GRP 4	GRP 1
MEAN	207.7500	218.5000	226.7083	258.5417	323.8750	326.8750	336.0417	357.3333
GROUP	GRP18	GRP21	GRP11	GRP13	GRP 9	GRP 1	GRP12	GRP24
MEAN	366.1667	377.6261	390.5417	428.2083	436.0000	441.3043	448.0417	472.8000
GROUP	GRP25	GRP 8	GRP10	GRP17	GRP 7	GRP16	GRP18	GRP 2
MEAN	486.9484	513.9583	519.1250	656.5833	1458.6250	1725.8333	2832.9167	4093.3000
GROUP	GRP20							
MEAN	817.1667							

FILE R00S (CREATION DATE = 02/26/78) STUDY

..... D N E W A Y

VARIABLE FCOL (Fecal Coliform)

ANALYSIS OF VARIANCE

SOURCE	D.F.	SUM OF SQUARES	MEAN SQUARES	F RATIO	F PROB.
BETWEEN GROUPS	24	119565099.1512	4981076.2146	3.932	0.0000
WITHIN GROUPS	530	671678253.6384	1266940.1012		
TOTAL	554	791043282.7904			

SUBSET 1

GROUP MEAN	GRP11	GRP22	GRP5	GRP24	GRP7	GRP10	GRP19	GRP21
	35.8750	37.7500	55.1667	58.6000	61.5000	73.2083	76.8583	77.1667
GROUP MEAN	GRP9	GRP6	GRP4	GRP1	GRP12	GRP16	GRP21	GRP8
	103.7500	105.2083	107.3333	107.7826	125.5417	186.5417	203.7826	210.2500
GROUP MEAN	GRP14	GRP3	GRP13	GRP25	GRP15	GRP17	GRP18	GRP20
	229.1667	259.9167	297.3750	373.5000	438.0833	456.7083	1226.2917	1287.5000

SUBSET 2

GROUP MEAN	GRP20
	1287.5000
	2304.0576

FILE R005 (CREATION DATE = 02/26/76) STUDY

O N E M A Y

VARIABLE PERS (Percent Saturation, Dissolved Oxygen)

ANALYSIS OF VARIANCE

SOURCE	D.F.	SUM OF SQUARES	MEAN SQUARES	F RATIO	F PROB.
BETWEEN GROUPS	24	38790.6511	1616.2771	2.969	0.0000
WITHIN GROUPS	473	257499.5355	544.3965		
TOTAL	497	296290.1866			

SUBSET 1

GROUP	GRP 2	GRP 21	GRP 22	GRP 24	GRP 20	GRP 11	GRP 14	GRP 10
MEAN	70.1677	85.6696	85.9338	88.0886	89.9674	92.7847	93.4108	95.8919
			85.9338	88.0886	89.9674			

SUBSET 2

GROUP	GRP 9	GRP 17	GRP 15	GRP 13	GRP 16	GRP 23	GRP 16	GRP 12
MEAN	96.1288	96.3808	96.8883	97.3924	99.0756	99.1026	99.1026	101.9558
GROUP	GRP 7	GRP 25						
MEAN	102.7346	103.9055						

SUBSET 3

GROUP	GRP 4	GRP 20	GRP 11	GRP 18	GRP 14	GRP 10	GRP 19	GRP 17
MEAN	88.0886	89.9674	92.7847	93.4108	93.8962	95.8915	96.1288	96.3808
GROUP	GRP 5	GRP 13	GRP 16	GRP 23	GRP 16	GRP 12	GRP 17	GRP 25
MEAN	96.8883	97.3924	99.0756	99.1026	101.9558	101.9558	102.7346	103.9055
GROUP	GRP 6	GRP 1	GRP 3	GRP 19	GRP 5			
MEAN	105.5468	106.2572	106.6912	108.2049	110.0915			

SUBSET 4

GROUP	GRP 20	GRP 11	GRP 18	GRP 14	GRP 10	GRP 19	GRP 17	GRP 14
MEAN	89.9674	92.7847	93.4108	93.8962	95.8915	96.1288	96.3808	96.8883

STATISTICAL PACKAGE FOR THE SOCIAL SCIENCES

GROUP	GRP 13	GRP 16	GRP 23	GRP 14	GRP 12	GRP 17	GRP 23	GRP 25
MEAN	97.3924	99.0756	99.1026	101.9558	101.9558	102.7346	103.9055	105.5468
GROUP	GRP 1	GRP 3	GRP 19	GRP 5	GRP 4			
MEAN	106.2572	106.6912	108.2049	110.0915	110.5060			

